

SMB780-1100-I High Power type Top LED

SMB780-1100-I is an AlGaAs LED mounted on copper heat sink with a 5*5 mm package
These devices are available to be operated and 725mW/sr at IFP=4A.

◆ Specifications

- 1) Product Name High Power Top LED
- 2) Type No. SMB780-1100-I
- 3) Chip
 - (1) Chip Material AlGaAs
 - (2) Chip Dimension 1000um*1000um
 - (3) Chip Number 1pce
 - (4) Peak Wavelength 780nm typ.
- 4) Package
 - (1) Lead Frame Die Silver Plated on Copper
 - (2) Insulator AlN ceramics
 - (3) Package Resin PPA Resin
 - (4) Lens Epoxy Resin

◆ Outer dimension (Unit: mm)

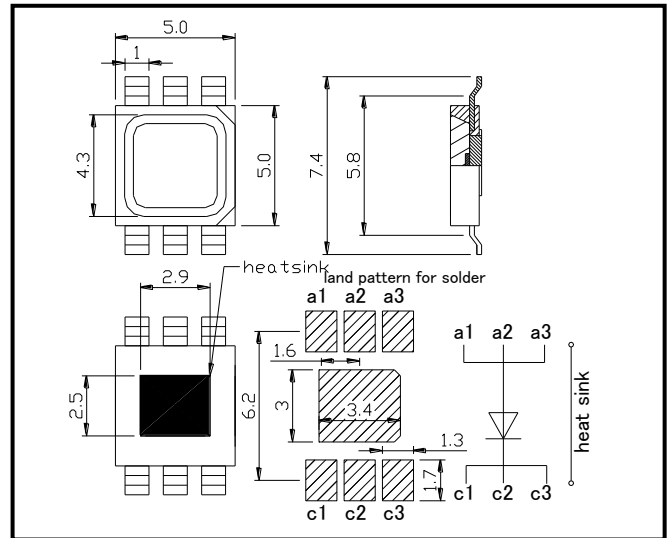

◆ Absolute Maximum Ratings

Item	Symbol	Maximum Rated Value	Unit	Ambient Temperature
Power Dissipation	P _D	2500	mW	T _a =25°C
Forward Current	I _F	800	mA	T _a =25°C
Pulse Forward Current	I _{FP}	4000	mA	T _a =25°C
Reverse Voltage	V _R	5	V	T _a =25°C
Thermal Resistance	R _{thja}	10	K/W	
Junction Temperature	T _j	100	°C	
Operating Temperature	T _{OPR}	-30 ~ +85	°C	
Storage Temperature	T _{STG}	-30 ~ +100	°C	
Soldering Temperature	T _{SOL}	255	°C	

‡Pulse Forward Current condition: Duty=1% and Pulse Width=10us.

‡Soldering condition: Soldering condition must be completed within 5 seconds at 255°C

◆ Electro-Optical Characteristics [T_a=25°C]

Item	Symbol	Condition	Minimum	Typical	Maximum	Unit
Forward Voltage	V _F	I _F =800mA		2.0	2.5	V
	V _{FP}	I _{FP} =4A		4.5	5.5	V
Radiated Power	P _O	I _F =800mA		330		mW
		I _{FP} =4A		1650		
Radiant Intensity	I _E	I _F =800mA		145		mW/sr
		I _{FP} =4A		725		
Peak Wavelength	λ _P	I _F =100mA		780		nm
Half Width	Δλ	I _F =100mA		25		nm
Viewing Half Angle	θ _{1/2}	I _F =100mA		±62		deg.
Rise Time	t _r	I _F =100mA		80		ns
Fall Time	t _f	I _F =100mA		80		ns

‡Radiated Power is measured by S3584-08.

‡Radiant Intensity is measured by Tektronix J-6512.

Forward Current - Forward Voltage

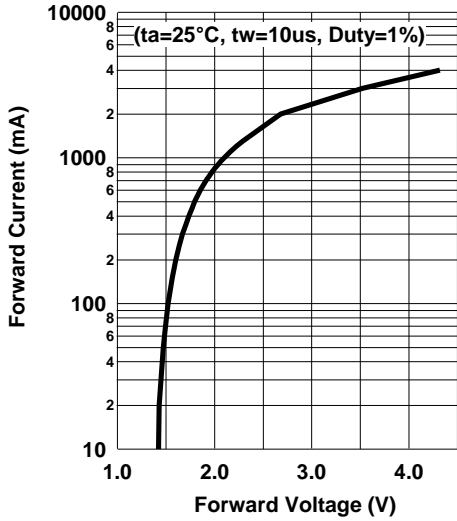

Relative Radiant Intensity - Forward Current

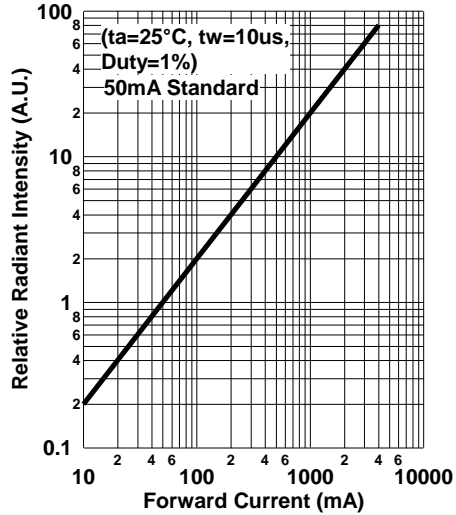

Forward Current-Pulse Duration

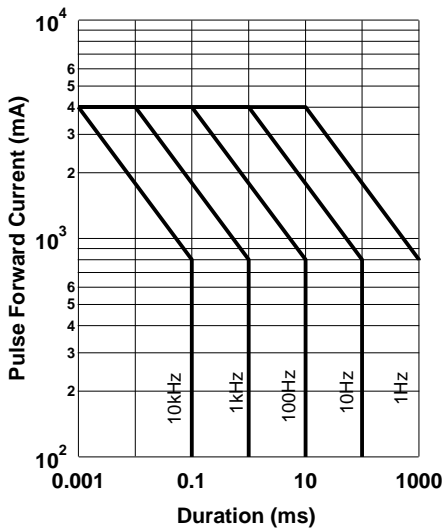

Allowable Forward Current - Ambient Temperature

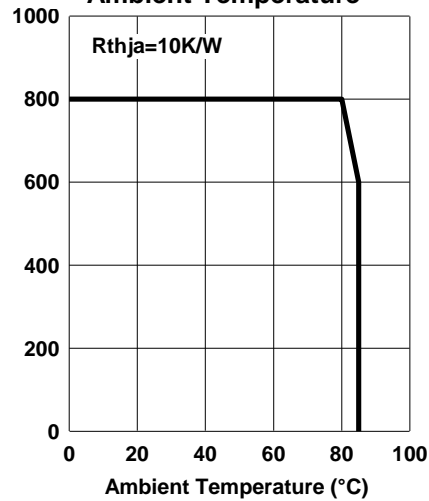

Relative Spectral Emission

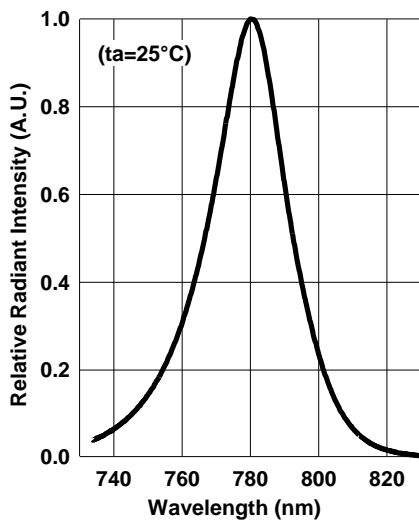

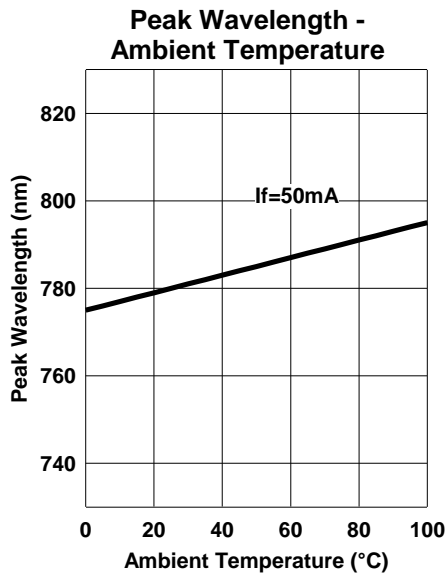
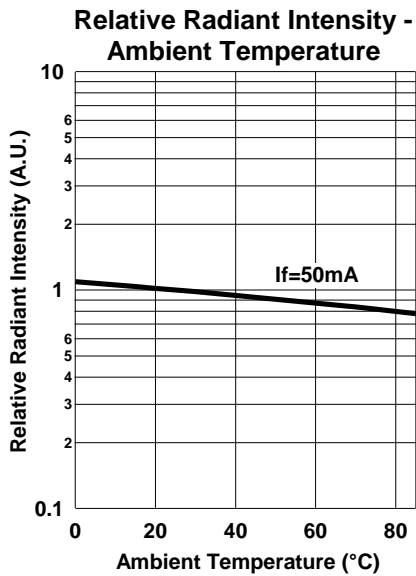
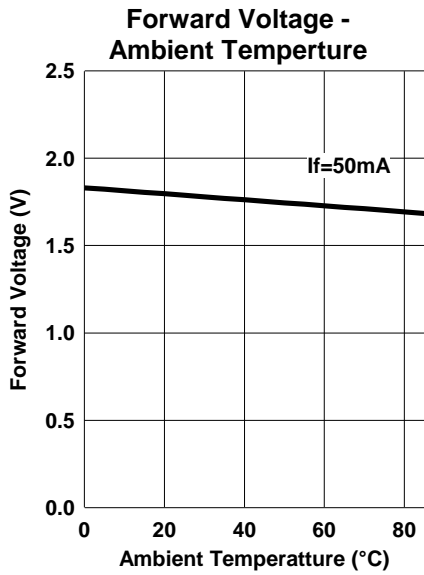

◆ Wrapping

Moisture barrier bag aluminum laminated film with a desiccant to keep out the moisture absorption during the transportation and storage.

Radiation Pattern

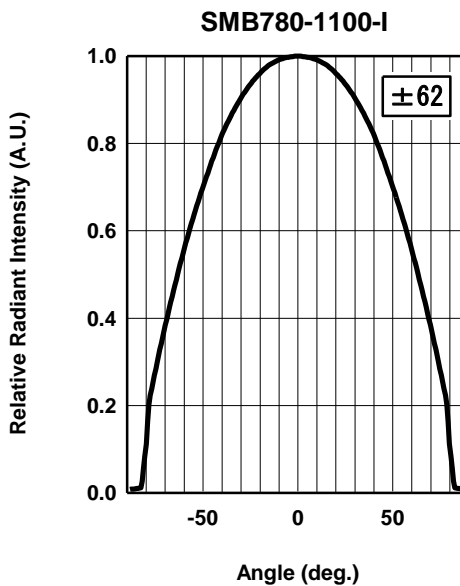
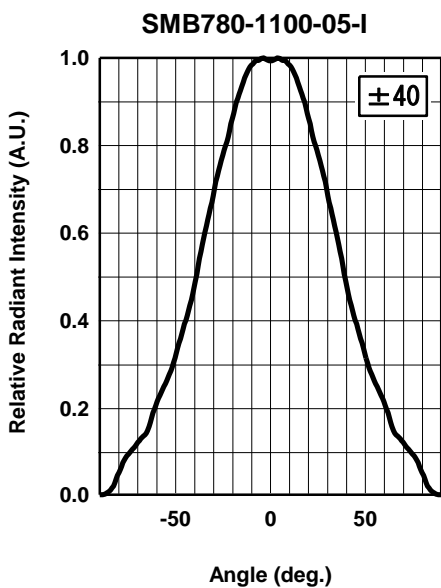
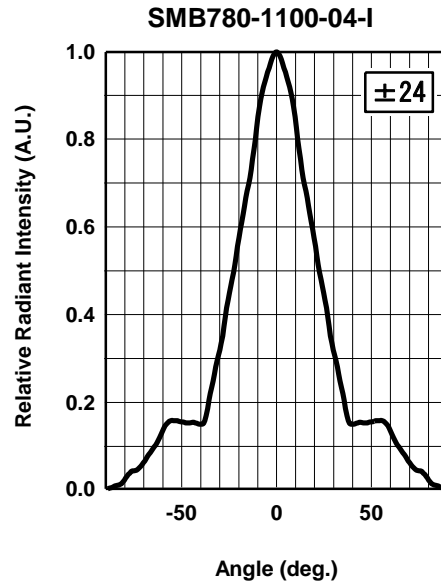
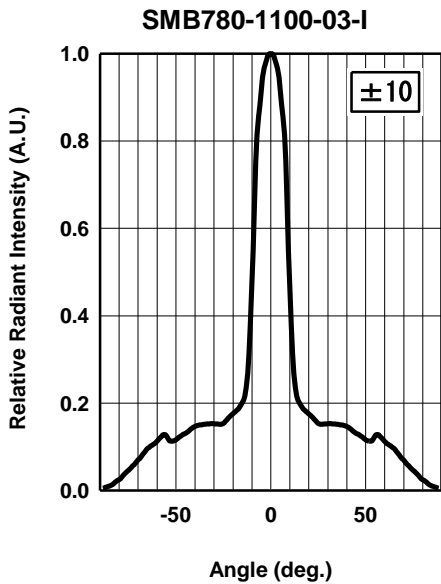
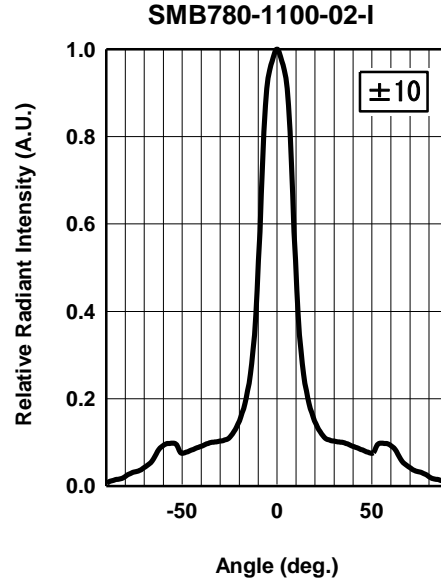
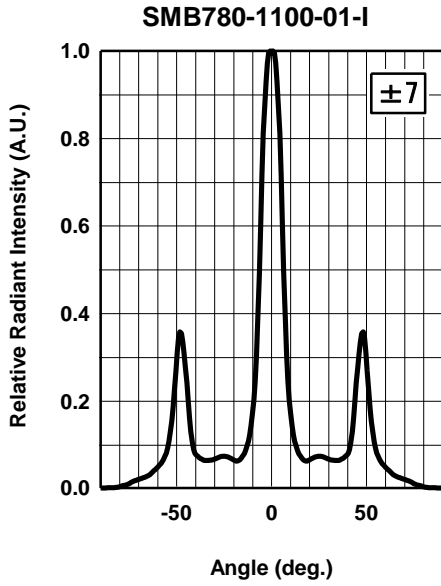

Radiation Pattern

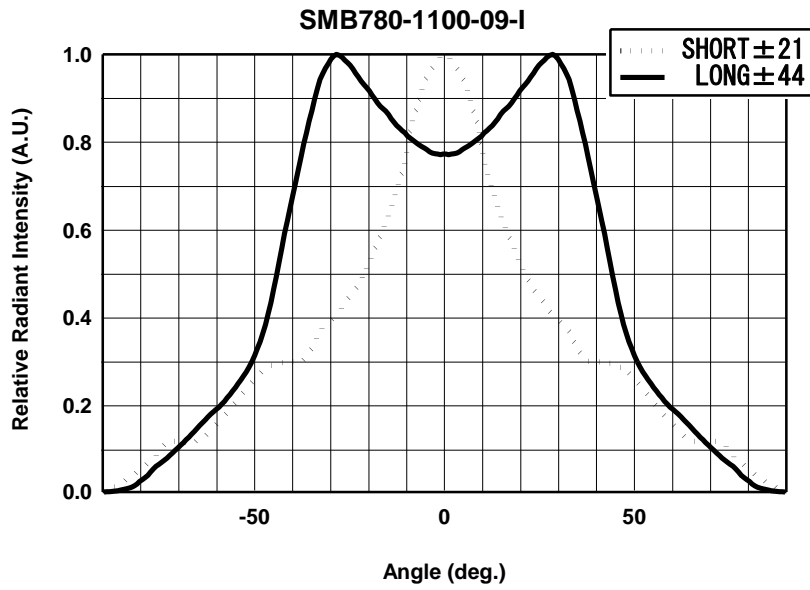

SMD LED STORAGE AND HANDLING PRECAUTIONS

< Storage Conditions before Opening a Moisture-Barrier Aluminum Bag >

- Before opening a moisture-barrier aluminum bag, please store it at <30°C, <60%RH. Please note that the maximum shelf life is 12 months under these conditions.

< Storage Conditions after Opening a Moisture-Barrier Aluminum Bag >

- After opening a moisture-barrier aluminum bag, store the aluminum bag and silica gel in a desiccator.
- After opening the bag, please solder the LEDs within 48 hours in a room with 5 - 30°C, <50%RH.
- Please put any unused, remaining LEDs and silica gel back in the same aluminum bag and then vacuum-seal the bag.
- It is recommended to keep the re-sealed bag in a desiccator at <30%RH.

< Notes about Re-sealing a Moisture-Barrier Aluminum Bag >

- When vacuum-sealing an opened aluminum bag, if you find the moisture-indicator of the silica gel has changed to pink from blue (indicating a relative humidity of 30 % or more), please do not use the unused LEDs, the aluminum bag, or the silica gel.

< Notes about Opening a Re-sealed Moisture-Barrier Aluminum Bag >

- When opening a vacuumed and re-sealed aluminum bag in order to use the remaining LEDs stored in the bag, if you find that the moisture-indicator of the silica has changed to pink, please do not use the LEDs.

※The 48-hour- long floor life does not include the time while LEDs are stored in the moisture-barrier aluminum bag.

However, we strongly recommend to solder the LEDs as soon as possible after opening the aluminum bag.

Marubeni America Corporation

3945 Freedom Circle, Suite 1000, Santa Clara, CA 95054
408-330-0650 (Ext. 330), 408-330-0655 (FAX), sales@tech-led.com