

**L690D-66-16100**  
Infrared Illuminator

<Specifications>

- Chip Material: AlGaInP
- Chip Dimension: 1000um x 1000um
- Number of Chips: 16pcs
- Peak Wavelength: 690nm typ.
- Stem: TO-66 Stem
- Lens: Silicone and/or Epoxy Resin

Outer Dimension (Unit:mm)

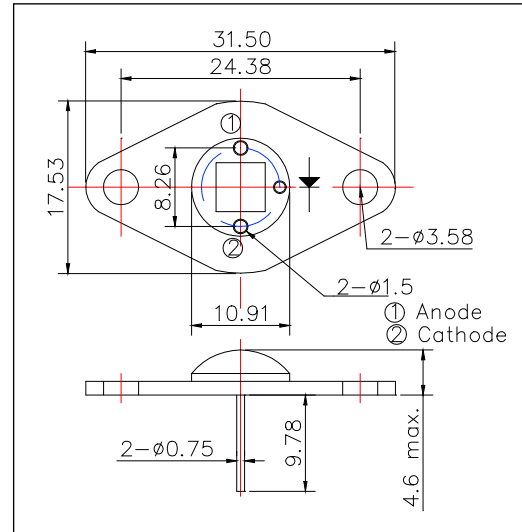

Absolute Maximum Ratings [Tc=25°C]			
Item	Symbol	Value	Unit
Power Dissipation	PD	30	W
Forward Current	IF	2400	mA
Reverse Voltage	VR	20	V
Thermal Resistance	Rthja	2	K/W
Junction Temperature	Tj	120	°C
Operating Temperature	TOPR	-40 ~ +85	°C
Storage Temperature	TSTG	-40 ~ +100	°C
Soldering Temperature*	TSOL	265	°C

\* Soldering condition must be completed within 3 second at 265°C.

Electro-Optical Characteristics [Tc=25°C]						
Item	Symbol	Condition	Minimum	Typical	Maximum	Unit
Forward Voltage	VF	IF=2.4A		10	12	V
Total Radiated Power*	PO	IF=2.4A		5900		mW
Peak Wavelength	$\lambda_P$	IF=2.4A	680		700	nm
Half Width	$\Delta\lambda$	IF=2.4A		25		nm
Viewing Half Angle	$\theta_{1/2}$	IF=100mA		$\pm 62$		deg
Rise Time	tr	IF=2.4A		50		ns
Fall Time	tf	IF=2.4A		40		ns

\* Measured by S3584-08



Typical Characteristic Curves

Forward Current - Forward Voltage

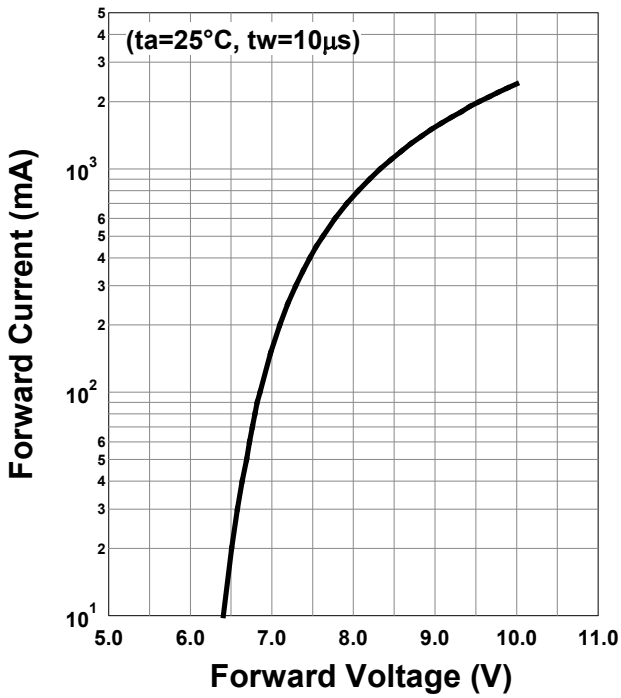

Relative Radiant Intensity - Forward Current

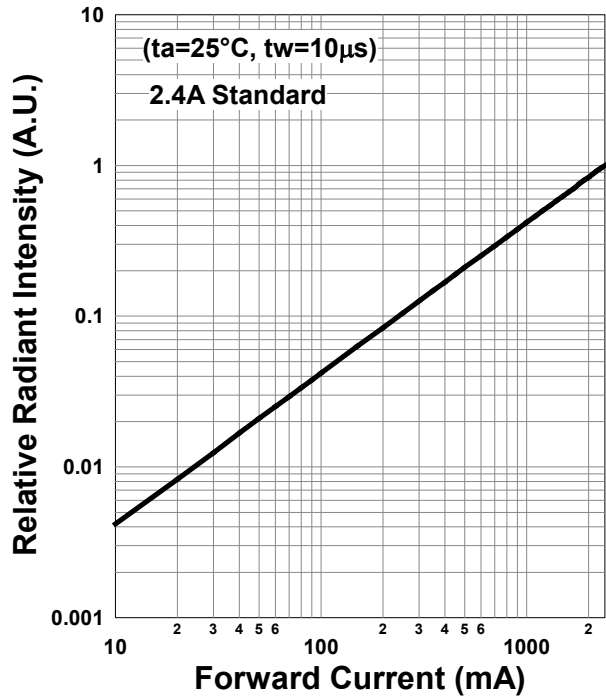

Allowable Forward Current - Ambient Temperature

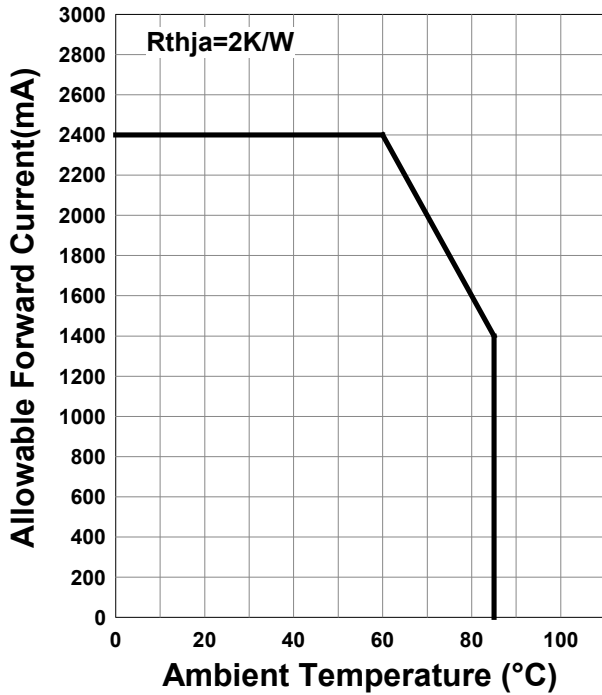

**Radiation Characteristics**

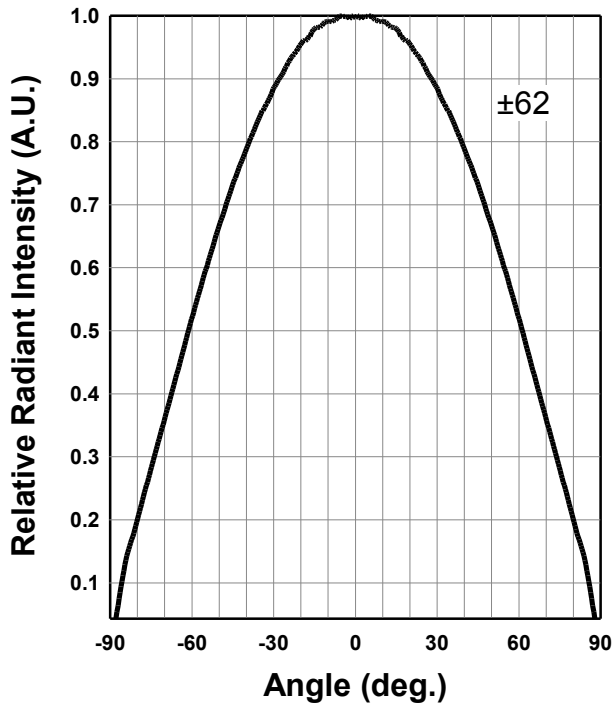

**Radiation Characteristics**

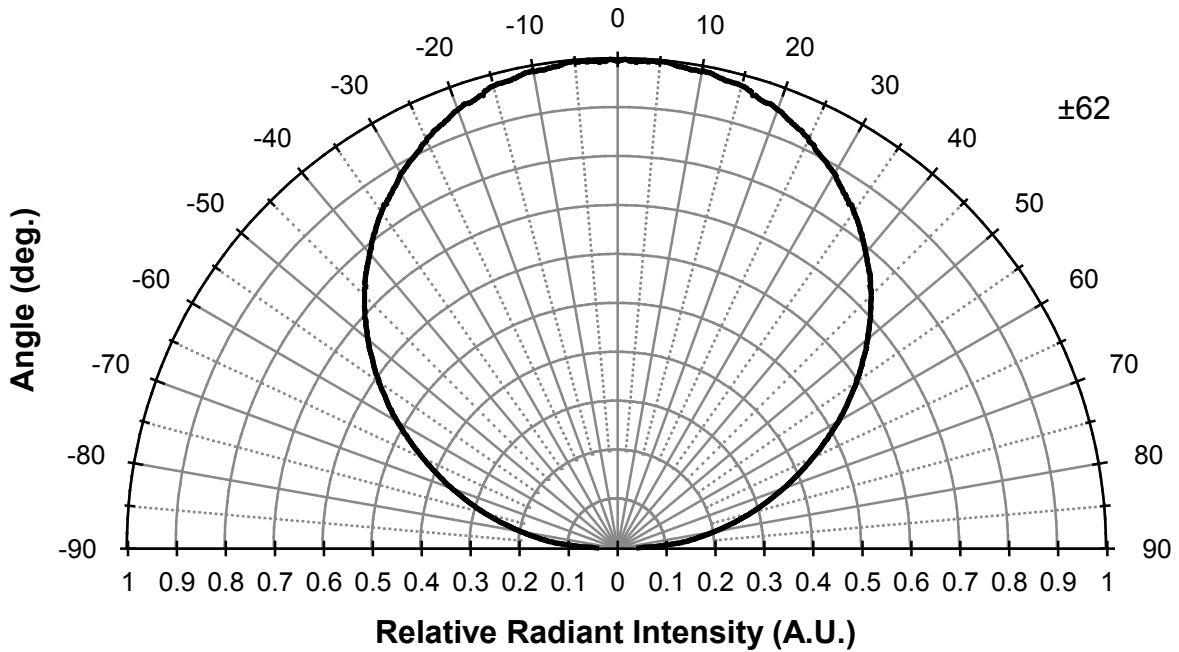

\*The data below shows the characteristics of one representative TO-66 chip.

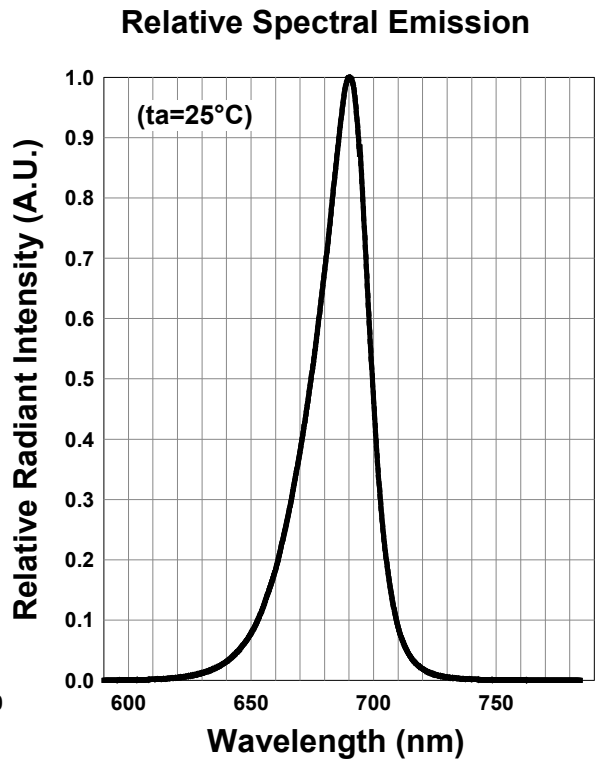
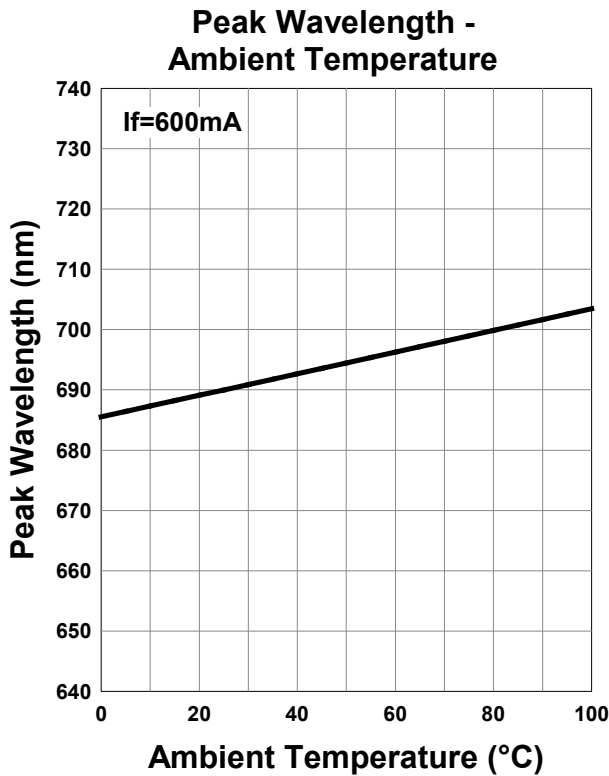
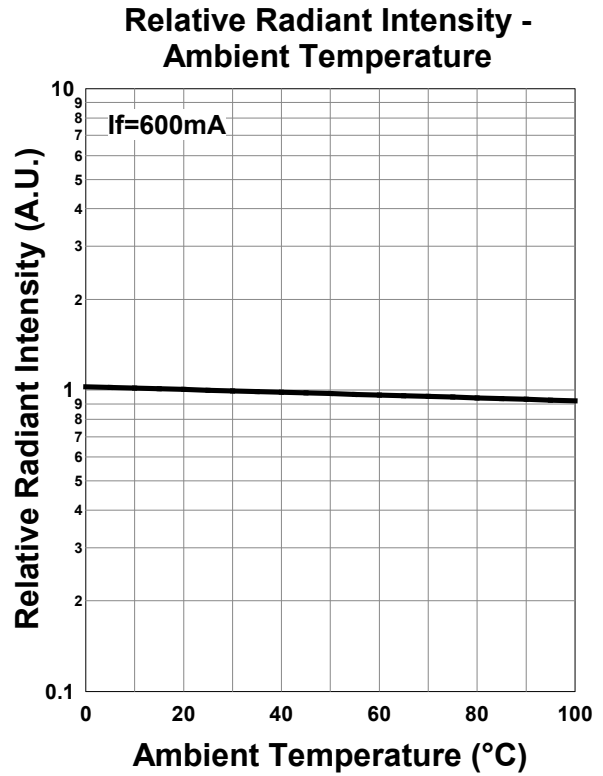
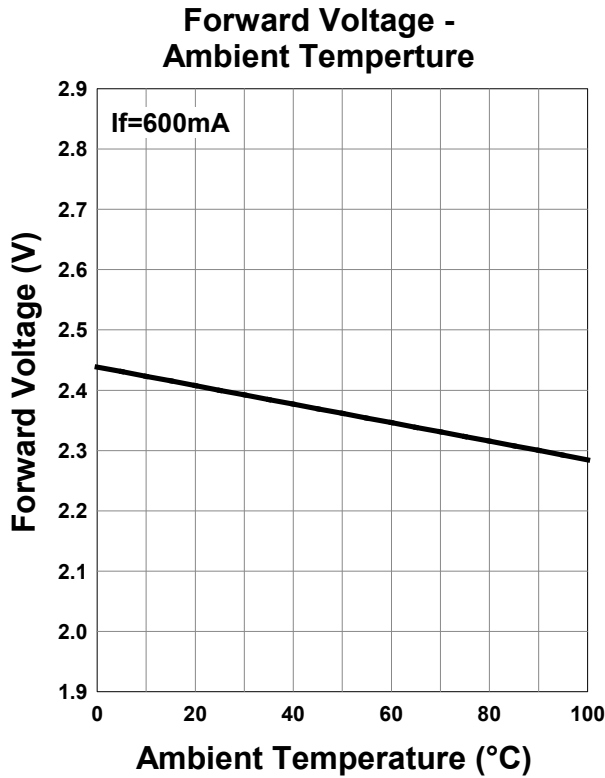

**Disclaimer**

Product specifications and data shown in this product catalog are subject to change without notice for the purposes of improving product performance, reliability, design, or otherwise.

Product data and parameters in this catalog are typical values based on reasonably up-to-date measurements.

Product data and parameters may vary by user application and over time.

Products shown in this catalog are intended to be used for general electronic equipment. Products are not guaranteed for applications where product malfunction or failure may cause personal injury or death, including but not limited to life-supporting / saving devices, medical devices, safety devices, airplanes, aerospace equipment, automobiles, traffic control systems, and nuclear reactor control systems.