

L545-05 Pure Green LED Lamp

L545-05 is an InGaN LED mounted on a lead frame with a clear epoxy resin. On forward bias, it emits a band of visible light that peaks 545nm.

<Specifications>

1. Product Name: Pure Green LED Lamp
2. Type Number: L545-05
3. Chip:
 - Chip material: InGaN
 - Peak Wavelength: 545nm typ.
4. Package
 - Type: Φ5mm Clear Molding
 - Resin Material: Epoxy Resin
 - Lead Frame: Soldered(Lead Free)

Outer Dimension (Unit:mm)

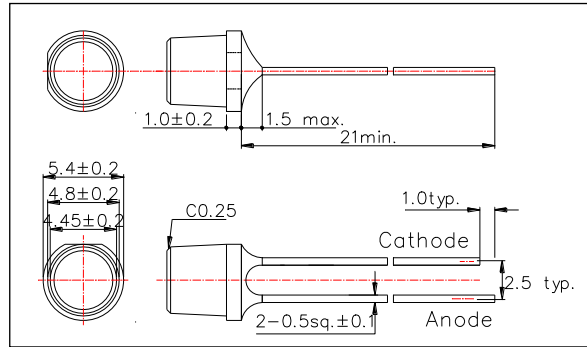

Absolute Maximum Ratings[Ta=25°C]			
Item	Symbol	Maximum Rated Value	Unit
Power Dissipation	PD	180	mW
Forward Current	IF	50	mA
Pulse Forward Current*	IFP	100	mA
Reverse Voltage	VR	5	V
Thermal Resistance**	Rthja	330	K/W
Junction Temperature	Tj	100	°C
Operating Temperature	TOPR	-40 ~ +85	°C
Storage Temperature	TSTG	-40 ~ +100	°C
Soldering Temperature***	TSOL	265	°C

* Duty=1% and Pulse Width=10us.

** Junction - ambient, leads 7mm, soldered on PCB.

*** Soldering condition must be completed within 3 second at 265 °C.

Electro-Optical Characteristics [Ta=25°C]							
Item	Symbol	Condition	Minimum	Typical	Maximum	Unit	
Forward Voltage	VF	IF=20mA		3.2		V	
Total Radiated Power*	PO	IF=20mA		2		mW	
Radiant Intensity**	IE	IF=20mA		0.7		mW/sr	
Brightness	IV	IF=20mA		440		mcd	
Wavelength	Peak	λP	IF=20mA	535	545	555	nm
	Dominant	λD	IF=20mA		558		
Half Width	Δλ	IF=20mA		36		nm	
Viewing Half Angle	θ1/2	IF=20mA		±43.5		deg	

* Measured by S3584-08

** Measured by Tektronix J-6512



Forward Current - Forward Voltage

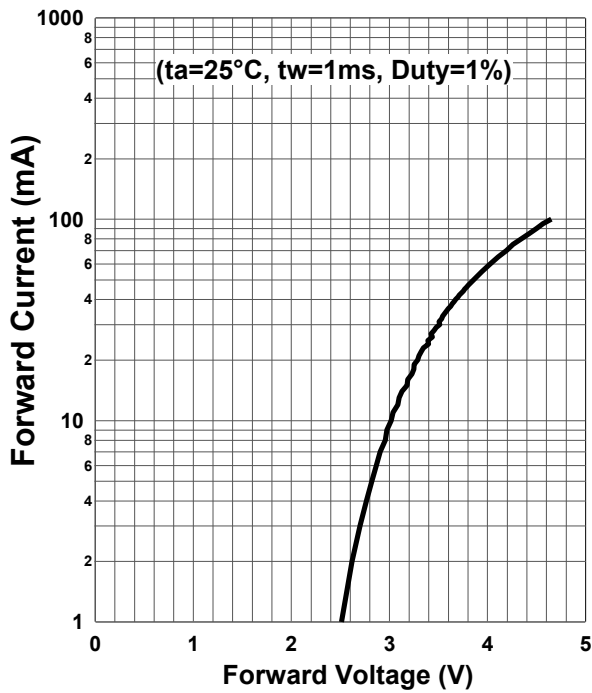

Relative Radiant Intensity - Forward Current

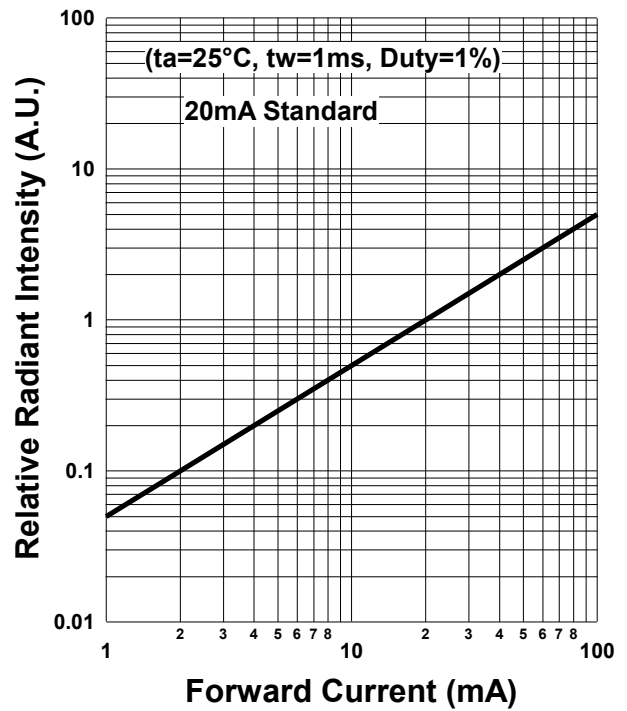

Forward Current - Pulse Duration

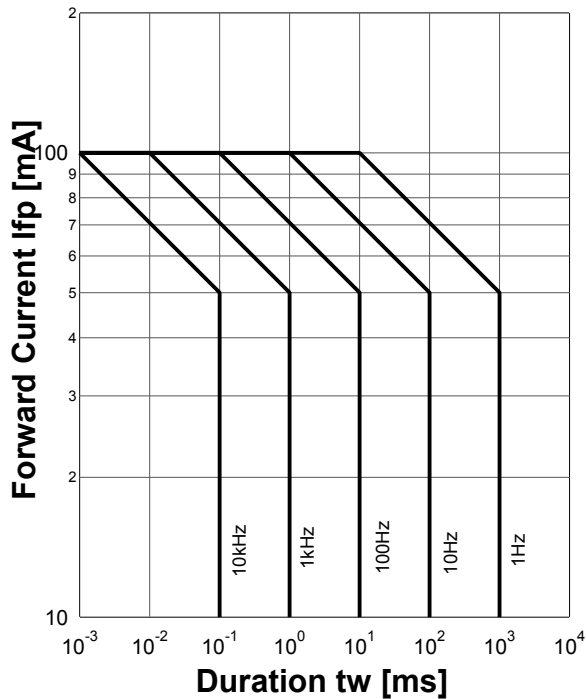

Allowable Forward Current - Ambient Temperature

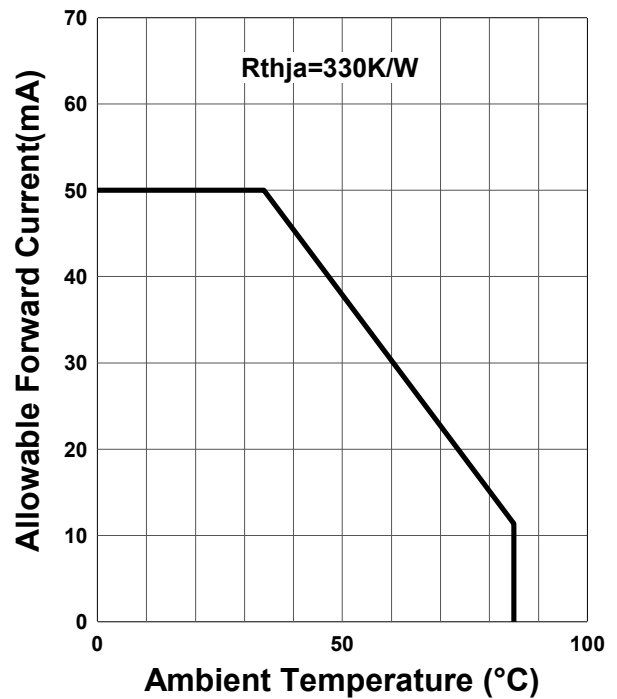

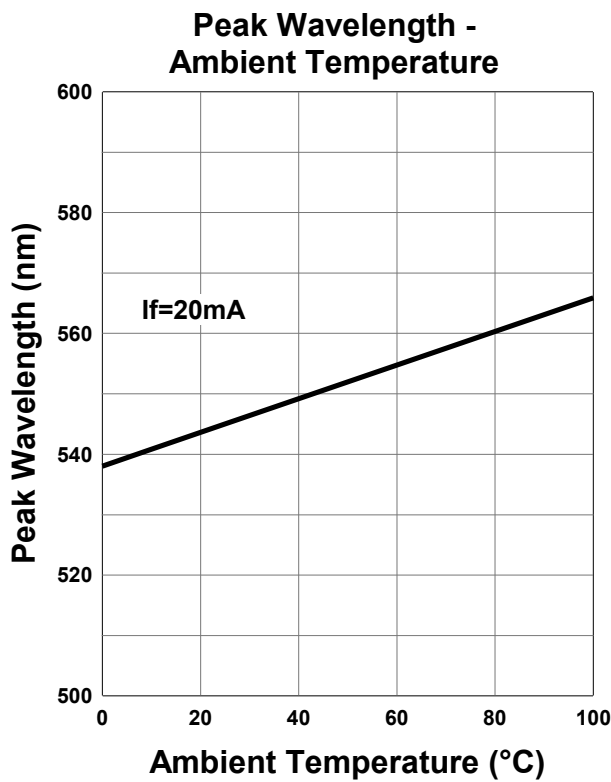
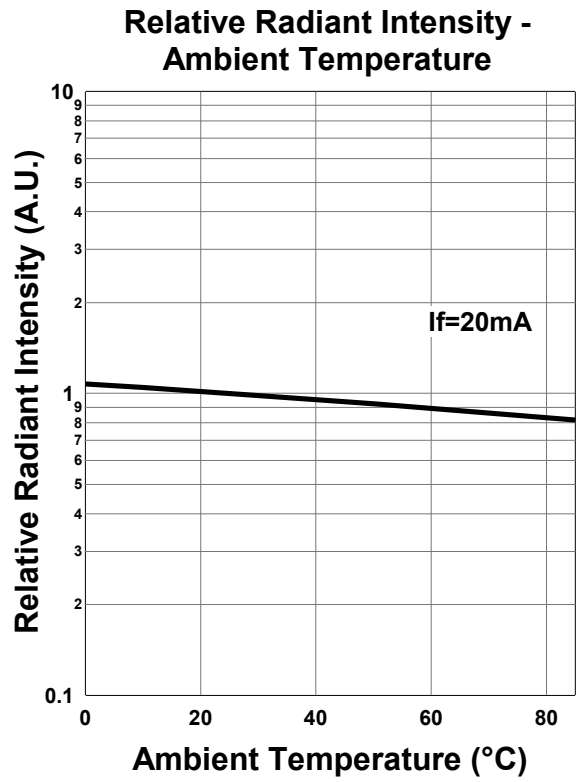
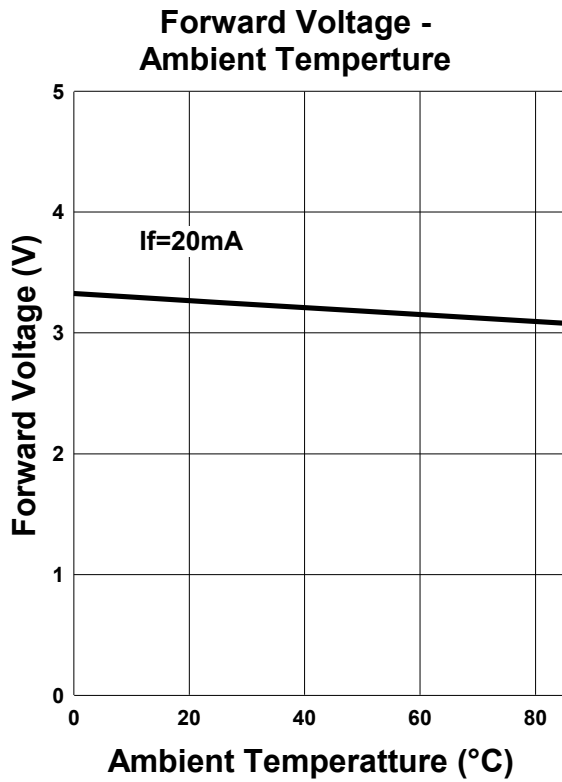

Relative Spectral Emission

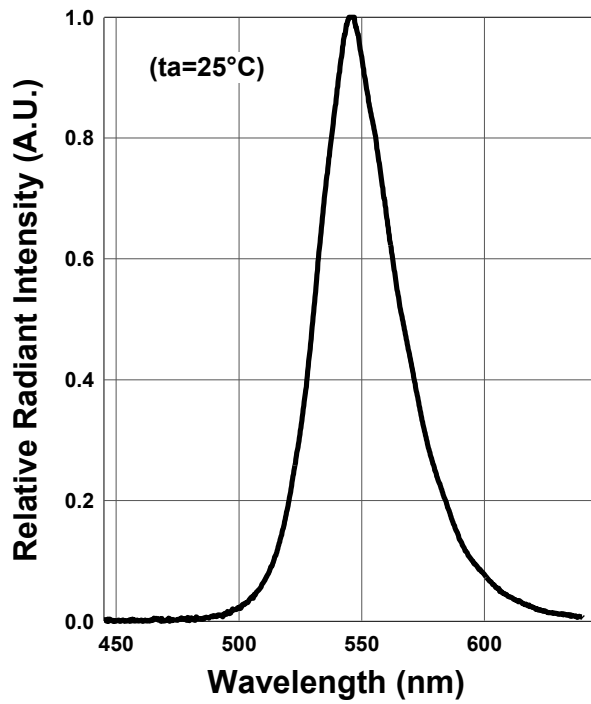

Radiation Characteristics

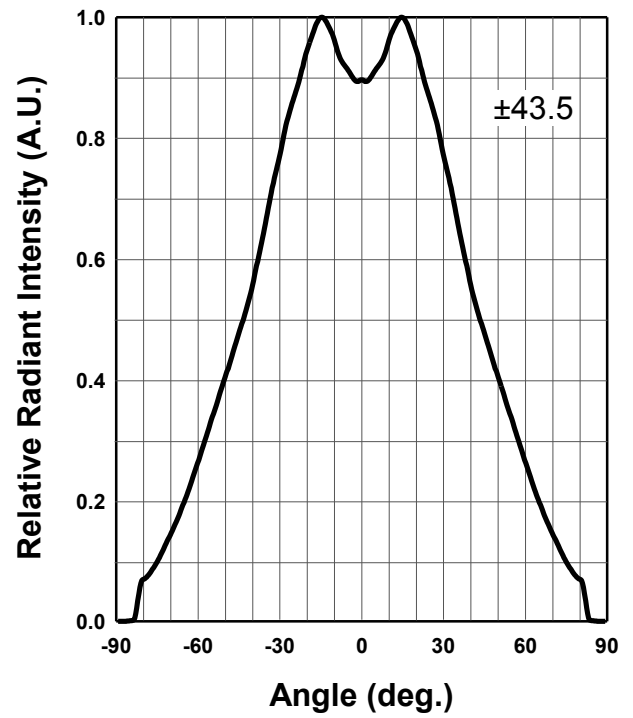

Disclaimer

Product specifications and data shown in this product catalog are subject to change without notice for the purposes of improving product performance, reliability, design, or otherwise.

Product data and parameters in this catalog are typical values based on reasonably up-to-date measurements. Product data and parameters may vary by user application and over time.

Products shown in this catalog are intended to be used for general electronic equipment. Products are not guaranteed for applications where product malfunction or failure may cause personal injury or death, including but not limited to life-supporting / saving devices, medical devices, safety devices, airplanes, aerospace equipment, automobiles, traffic control systems, and nuclear reactor control systems.