

## L590-05 High Bright Yellow LED Lamp

<Specifications>

- Chip Material: AlGaInP
- Chip DimensionL 350um x 350um
- Number of Chips: 1pcs
- Peak Wavelength: 590nm typ.
- Package Type: Φ5mm Clear Molding
- Lead Frame: Soldered (Lead Free)
- Lens: Epoxy Resin

Outer Dimension (Unit:mm)

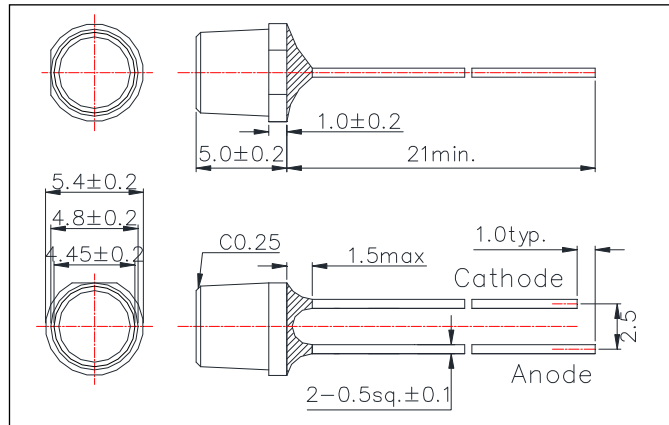

Absolute Maximum Ratings[Tc=25°C]			
Item	Symbol	Value	Unit
Power Dissipation	PD	120	mW
Forward Current	IF	50	mA
Pulse Forward Current*	IFP	100	mA
Reverse Voltage	VR	5	V
Thermal Resistance	Rthja	350	K/W
Junction Temperature	Tj	120	°C
Operating Temperature	TOPR	-40 ~ +100	°C
Storage Temperature	TSTG	-40 ~ +100	°C
Soldering Temperature**	TSOL	265	°C

\* Duty 1% and Pulse Width = 10us.

\*\* Soldering condition must be completed within 3 second at 265°C.

Electro-Optical Characteristics [Tc=25°C]						
Item	Symbol	Condition	Minimum	Typical	Maximum	Unit
Forward Voltage	VF	IF=20mA		2.1	2.3	V
	VFP	IFP=100mA		2.5		
Total Radiated Power*	PO	IF=20mA		2.9		mW
		IFP=100mA		15		
Radiant Intensity**	IE	IF=20mA		2.0		mW/sr
		IFP=100mA		15		
Brightness	IV	IF=20mA		430		mcd
Luminous Flux	ΦV	IF=20mA		2300		mlm
Peak Wavelength	λP	IF=20mA	580		600	nm
Half Width	Δλ	IF=20mA		14		nm
Viewing half Angle	θ1/2	IF=20mA		±49		deg
Rise Time	tr	IF=20mA		30		ns
Fall Time	tf	IF=20mA		25		ns

\* Measured by S3584-08

\*\* Measured by CIE127-2007 Condition B



Typical Characteristic Curves

**Forward Current - Forward Voltage**

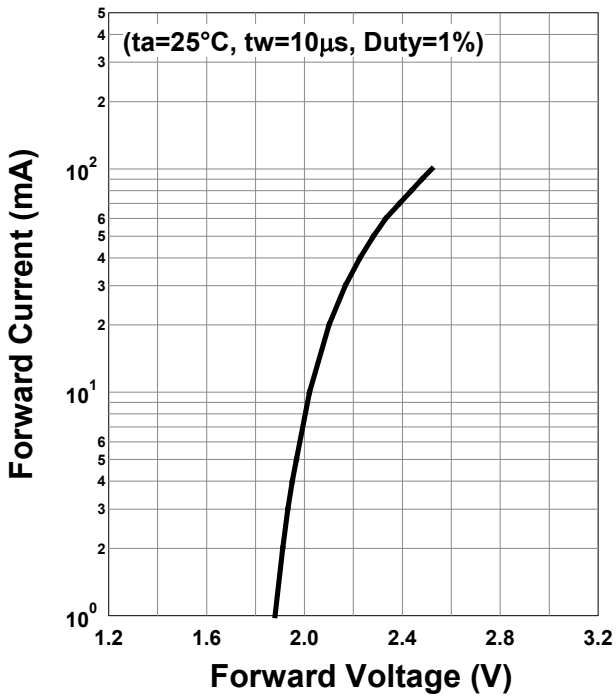

**Relative Radiant Intensity - Forward Current**

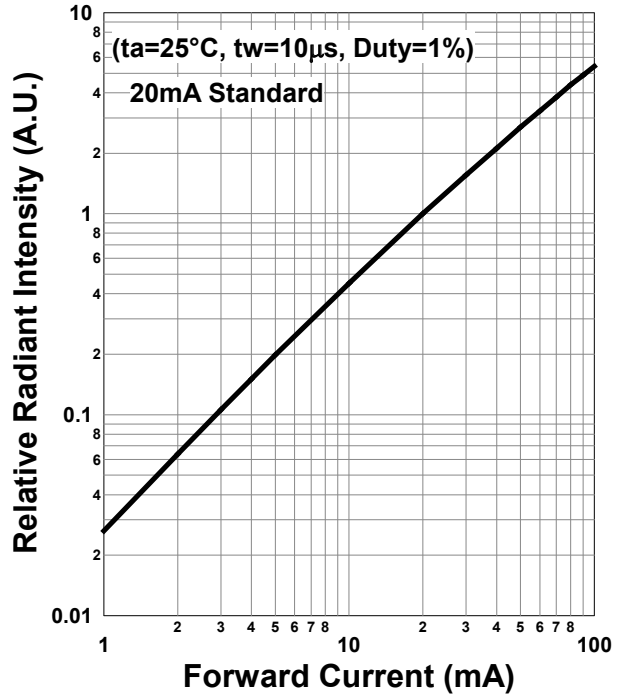

**Forward Current - Pulse Duration**

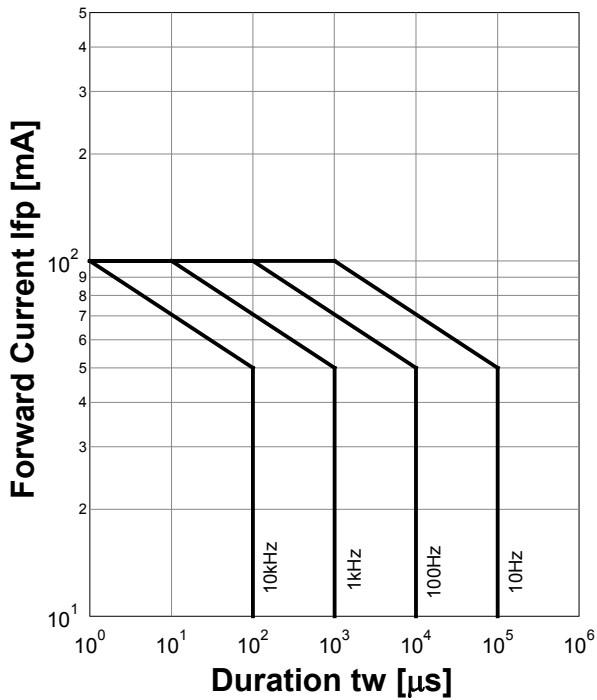

**Allowable Forward Current - Ambient Temperature**

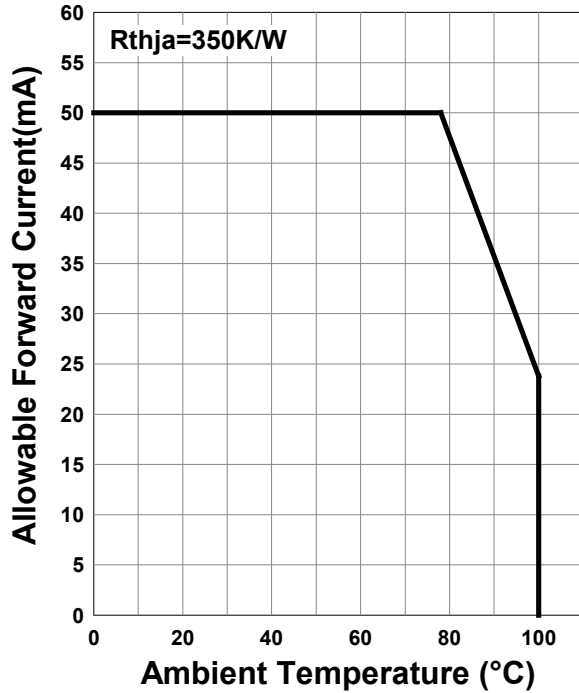

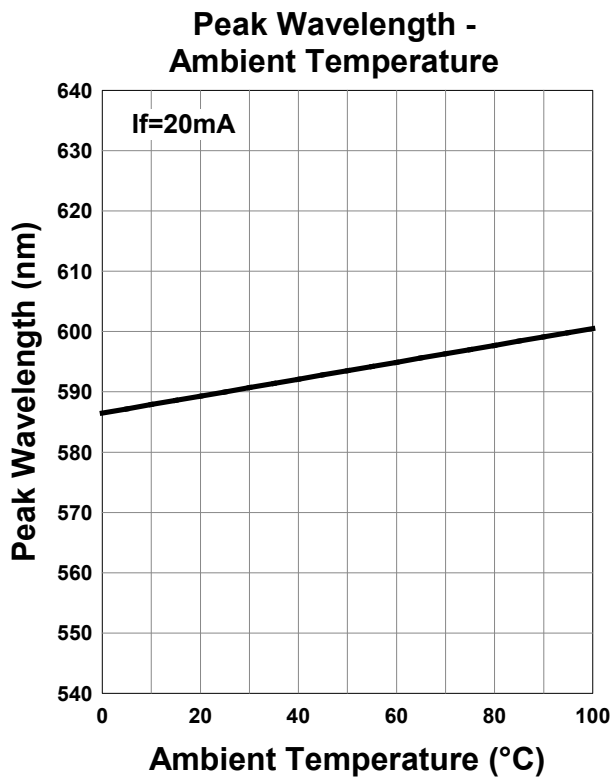
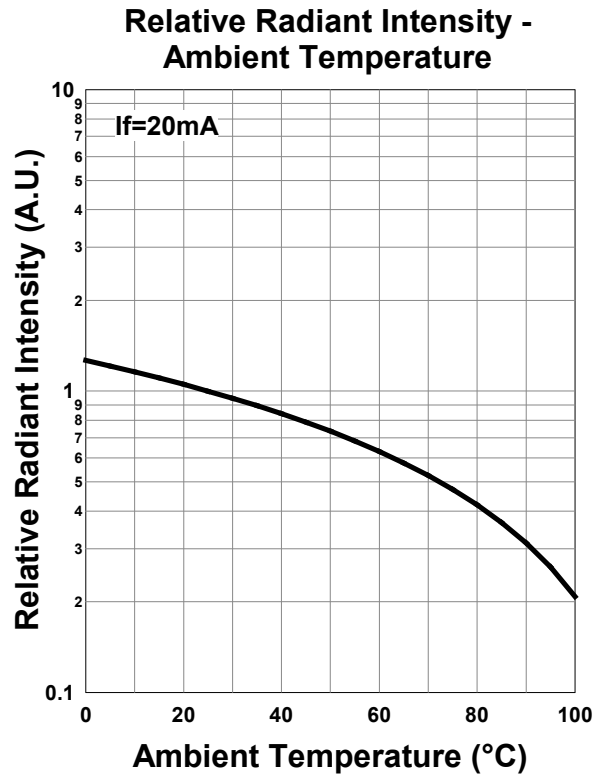
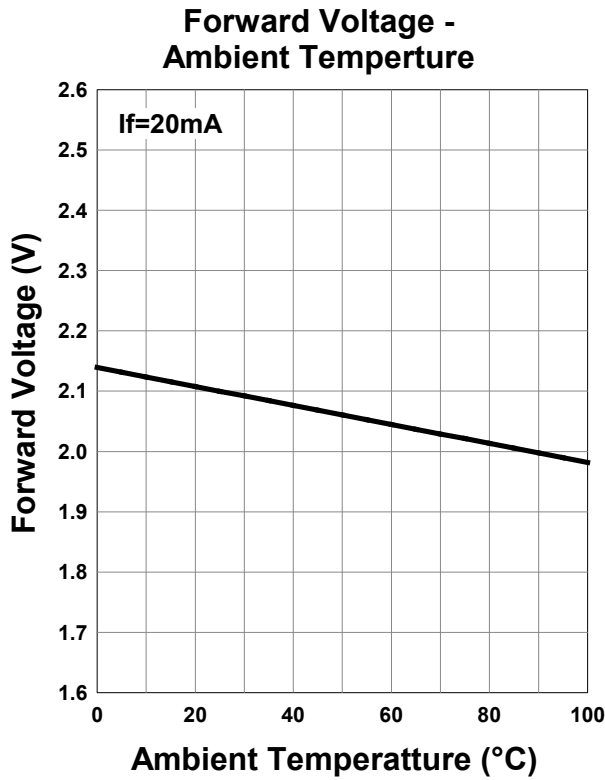

**Relative Spectral Emission**

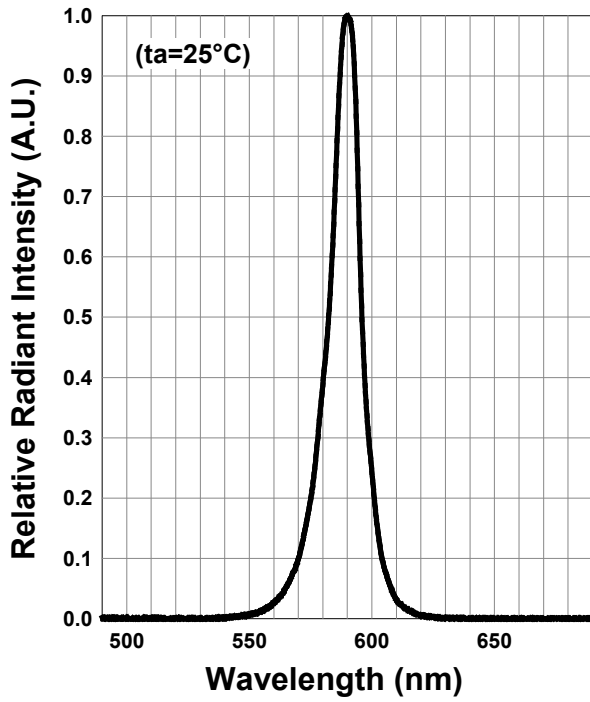

**Radiation Characteristics**

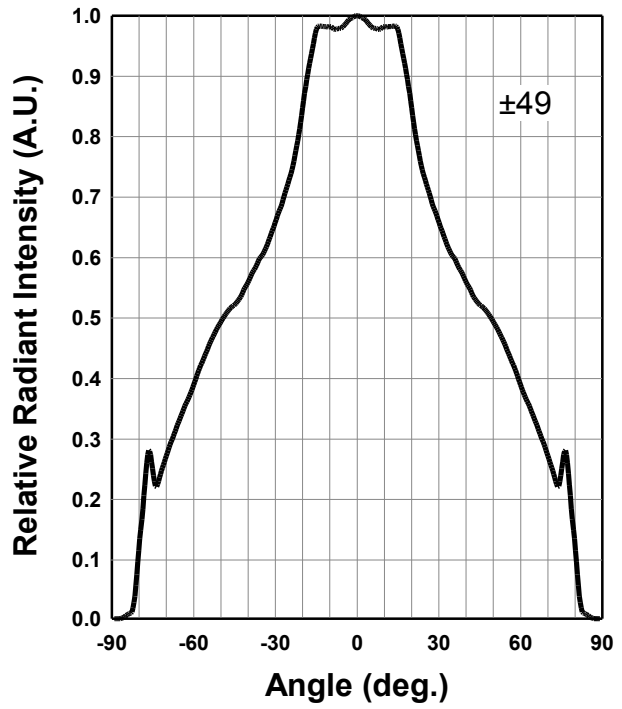

**Radiation Characteristics**

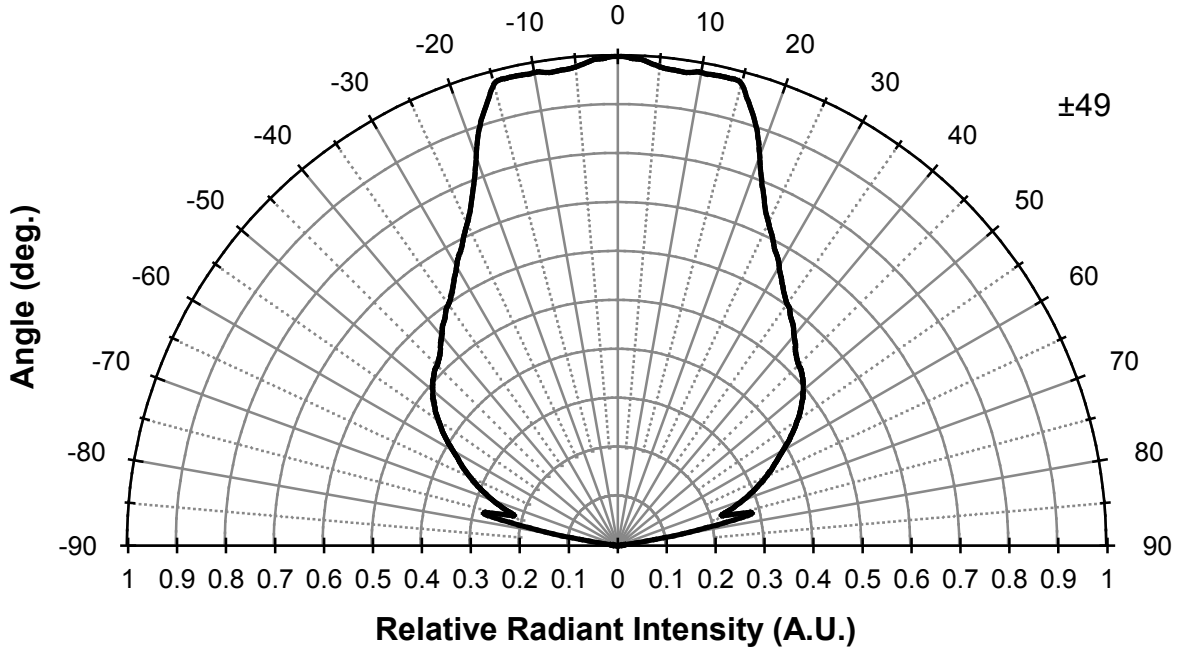

**Disclaimer**

Product specifications and data shown in this product catalog are subject to change without notice for the purposes of improving product performance, reliability, design, or otherwise.

Product data and parameters in this catalog are typical values based on reasonably up-to-date measurements. Product data and parameters may vary by user application and over time.

Products shown in this catalog are intended to be used for general electronic equipment. Products are not guaranteed for applications where product malfunction or failure may cause personal injury or death, including but not limited to life-supporting / saving devices, medical devices, safety devices, airplanes, aerospace equipment, automobiles, traffic control systems, and nuclear reactor control systems.

2016.07