

**L770-06AU**  
Infrared LED Lamp

<Specifications>

- Chip Material: AlGaAs
- Chip Dimension: 400um x 400um
- Number of Chips: 1pcs
- Peak wavelength: 77nm Typ.
- Package Type: Φ5mm Clear Molding
- Lead Frame: Soldered (Lead Free)
- Lens: Epoxy Resin

Outer Dimension (Unit:mm)

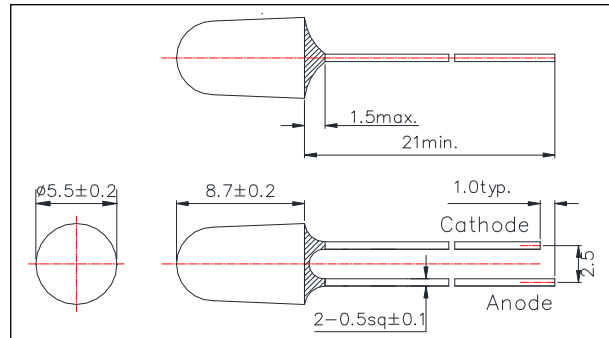

Absolute Maximum Ratings[Tc=25°C]			
Item	Symbol	Maximum Rated Value	Unit
Power Dissipation	PD	220	mW
Forward Current	IF	100	mA
Pulse Forward Current*	IFP	500	mA
Reverse Voltage	VR	5	V
Thermal Resistance	Rthja	190	K/W
Junction Temperature	Tj	120	°C
Operating Temperature	TOPR	-40 ~ +100	°C
Storage Temperature	TSTG	-40 ~ +100	°C
Soldering Temperature**	TSOL	265	°C

\* Duty=1% and Pulse Width=10us.

\*\* Soldering condition must be completed within 3 second at 265 °C.

Electro-Optical Characteristics[Tc=25°C]						
Item	Symbol	Condition	Min	Typ	Max	Unit
Forward Voltage	VF	IF=50mA		1.8	2.2	V
	VFP	IFP=500A		3.8		
Total Radiated Power*	PO	IF=50mA		26		mW
		IFP=500A		270		
Radiant Intensity**	IE	IF=50mA		250		mW/sr
		IFP=500A		2600		
Peak Wavelength	λP	IF=50mA	760		780	nm
Half Width	Δλ	IF=50mA		26		nm
Viewing Half Angle	θ1/2	IF=50mA		±7		deg
Rise Time	tr	IF=50mA		10		ns
Fall Time	tf	IF=50mA		15		ns

\* Measured by S3584-08

\*\* Measured by CIE127-2007 Condition B



Typical Characteristic Curves

Forward Current - Forward Voltage

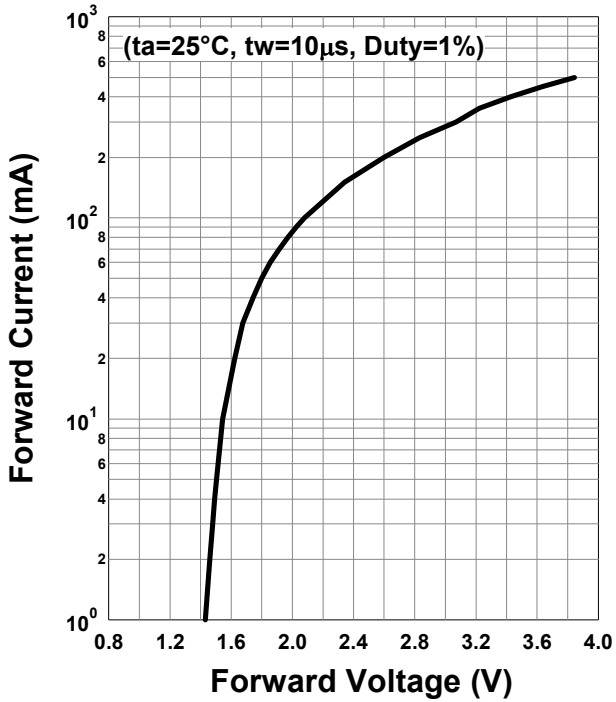

Relative Radiant Intensity - Forward Current

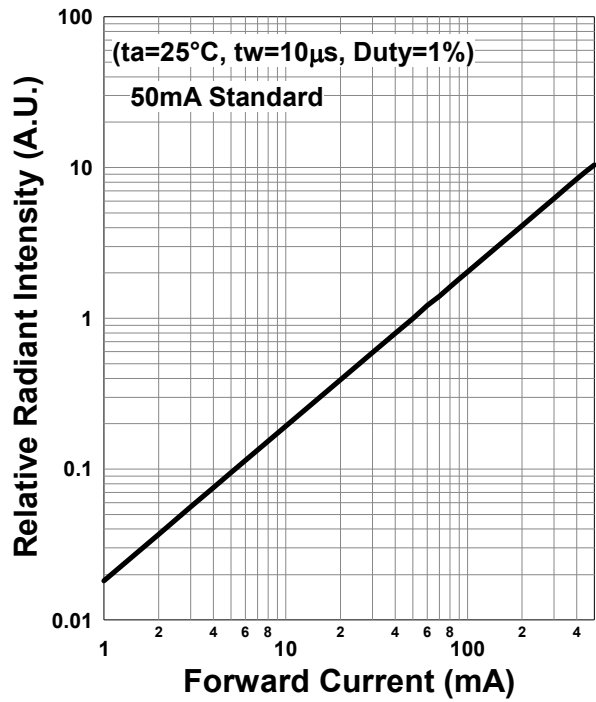

Forward Current - Pulse Duration

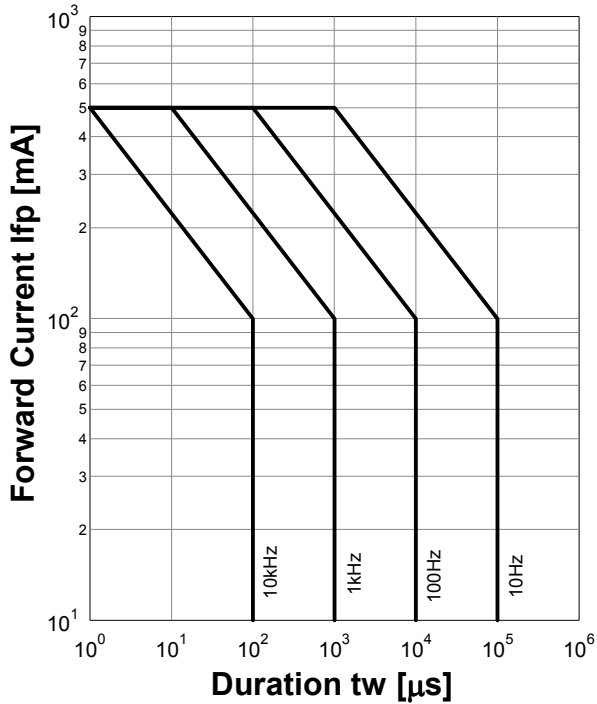

Allowable Forward Current - Ambient Temperature

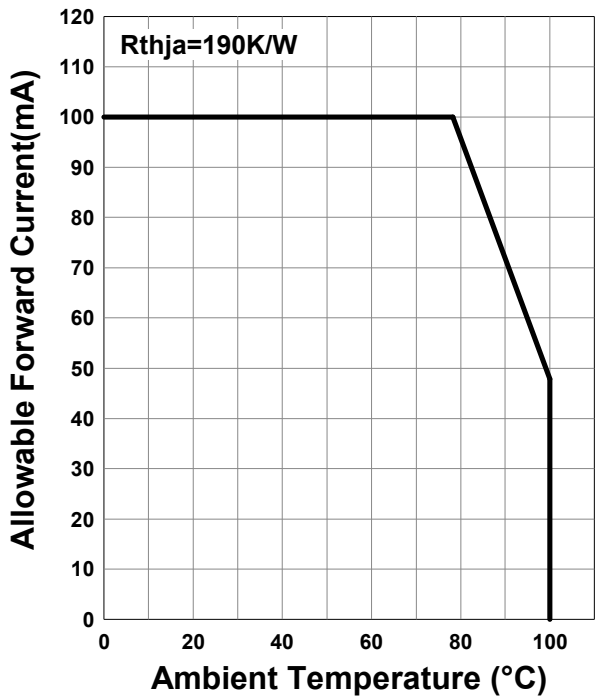

**Forward Voltage - Ambient Temperature**

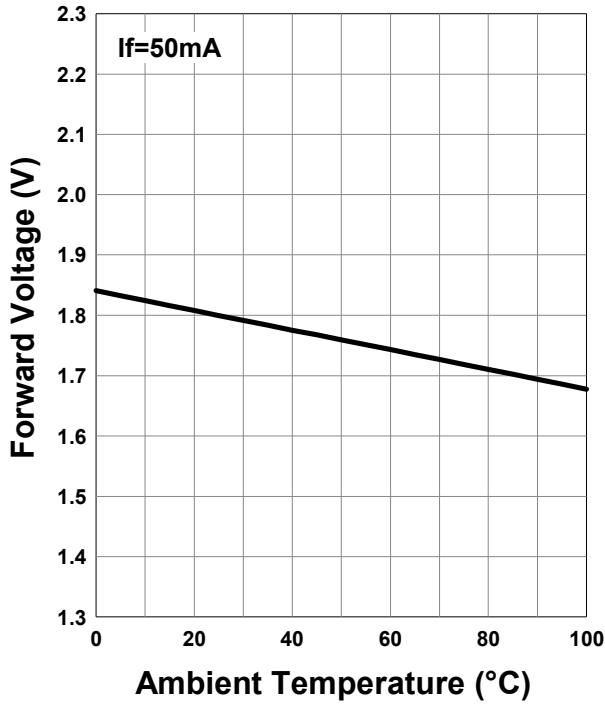

**Relative Radiant Intensity - Ambient Temperature**

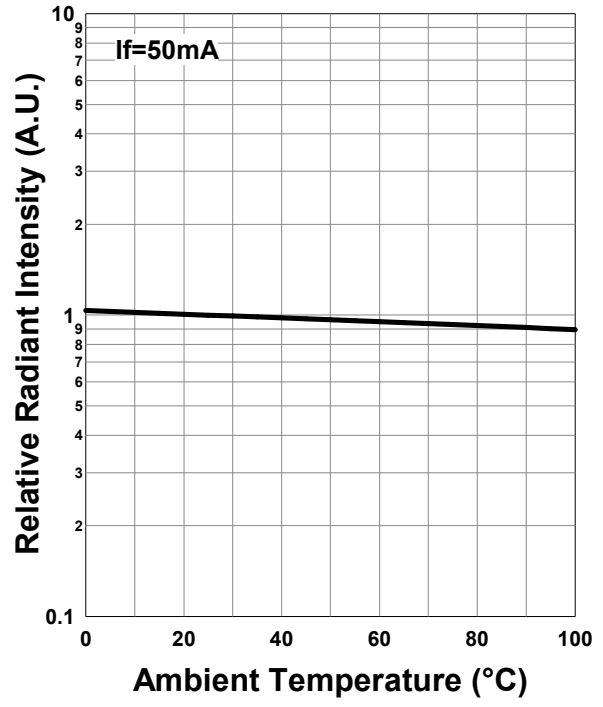

**Peak Wavelength - Ambient Temperature**

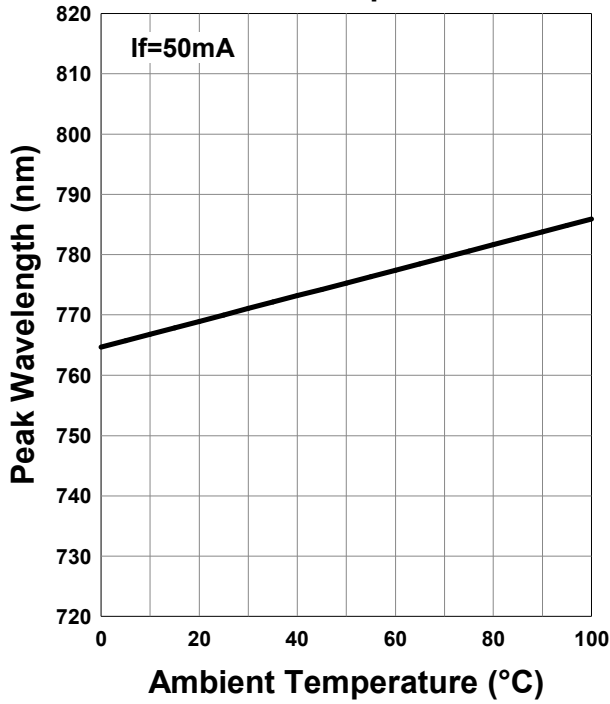

**Relative Spectral Emission**

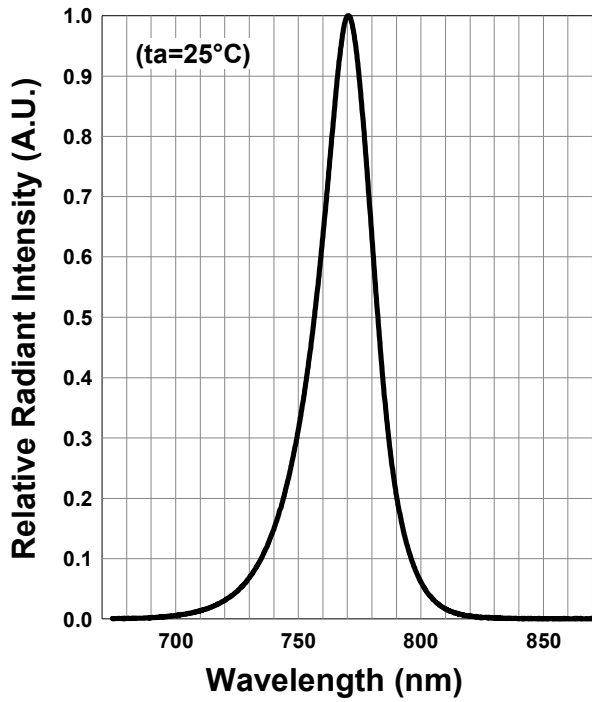

**Radiation Characteristics**

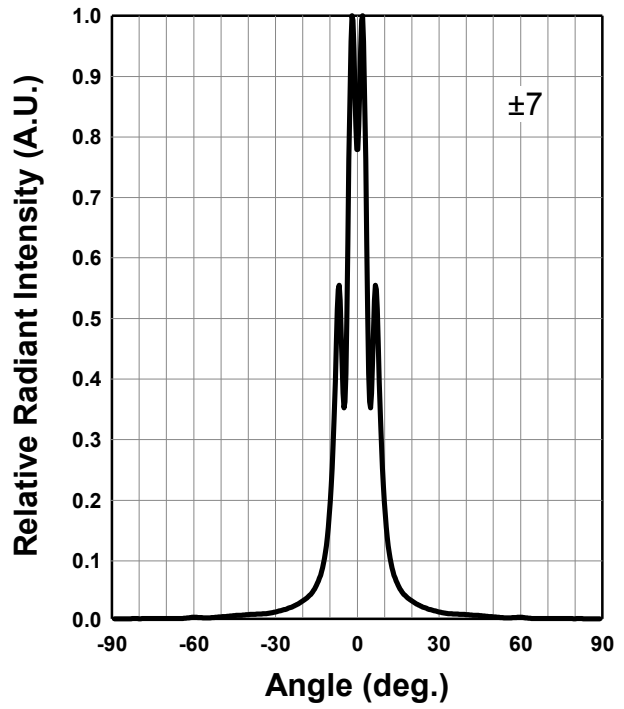

**Radiation Characteristics**

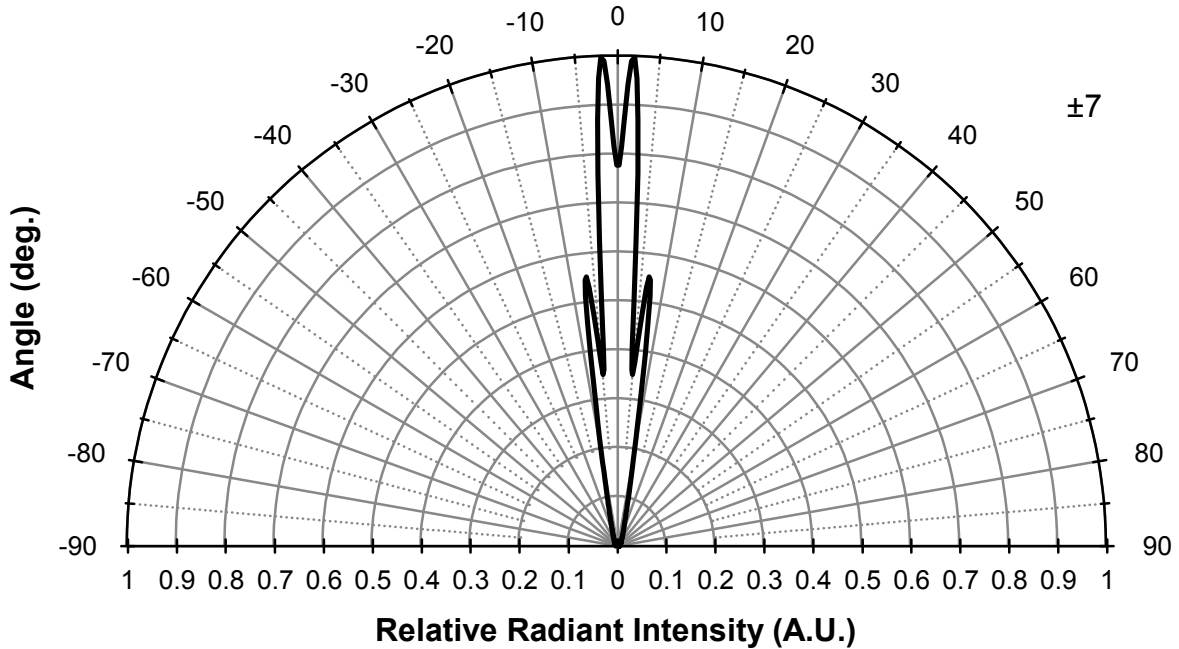

**Disclaimer**

Product specifications and data shown in this product catalog are subject to change without notice for the purposes of improving product performance, reliability, design, or otherwise.

Product data and parameters in this catalog are typical values based on reasonably up-to-date measurements.

Product data and parameters may vary by user application and over time.

Products shown in this catalog are intended to be used for general electronic equipment. Products are not guaranteed for applications where product malfunction or failure may cause personal injury or death, including but not limited to life-supporting / saving devices, medical devices, safety devices, airplanes, aerospace equipment, automobiles, traffic control systems, and nuclear reactor control systems.

2017.04