

SMT570

High Performance Yellow Green Color TOP LED

<Specifications>

- Chip Material: AlGaInP
- Chip Dimension: 300um x 300um
- Number of Chips: 1pcs
- Peak Wavelength: 570nm typ.
- Lead Frame Die: Silver Plated on Copper
- Package Resin: PA6T
- Lens: Silicone or Epoxy Resin

Outer Dimension (Unit:mm)

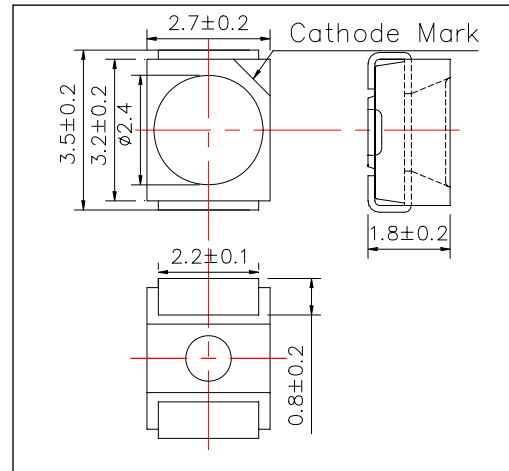

Absolute Maximum Ratings[Tc=25°C]			
Item	Symbol	Maximum Rated Value	Unit
Power Dissipation	PD	50	W
Forward Current	IF	20	mA
Pulse Forward Current*	IFP	100	mA
Reverse Voltage	VR	5	V
Thermal Resistance	Rthja	80	K/W
Junction Temperature	Tj	100	°C
Operating Temperature	TOPR	-40 ~ +85	°C
Storage Temperature	TSTG	-40 ~ +100	°C
Soldering Temperature**	TSOL	250	°C

* Duty 1% and Pulse Width=10us.

** Soldering condition must be completed within 5 second at 250°C.

Electro-Optical Characteristics[Tc=25°C]						
Item	Symbol	Condition	Min	Typ	Max	Unit
Forward Voltage	VF	IF=20mA		2.1	2.5	V
	VFP	IFP=100mA		2.3		
Total Radiated Power*	PO	IF=20mA		0.6		mW
		IFP=100mA		3.2		
Radiant Intensity**	IE	IF=20mA		0.51		mW/sr
		IFP=100mA		2.7		
Brightness	Iv	IF=20mA		110		mcd
Luminous Flux	ΦV	IF=20mA		380		mlm
Peak Wavelength	λP	IF=20mA	560		580	nm
Dominant Wavelength	λD	IF=20mA		568		nm
Half Width	Δλ	IF=20mA		11		nm
Viewing Half Angle	θ1/2	IF=20mA		±61		deg
Rise Time	tr	IF=20mA		50		ns
Fall Time	tf	IF=20mA		30		ns

* Measured by S3584-08

** Measured by CIE127-2007 Condition B

Forward Current - Forward Voltage

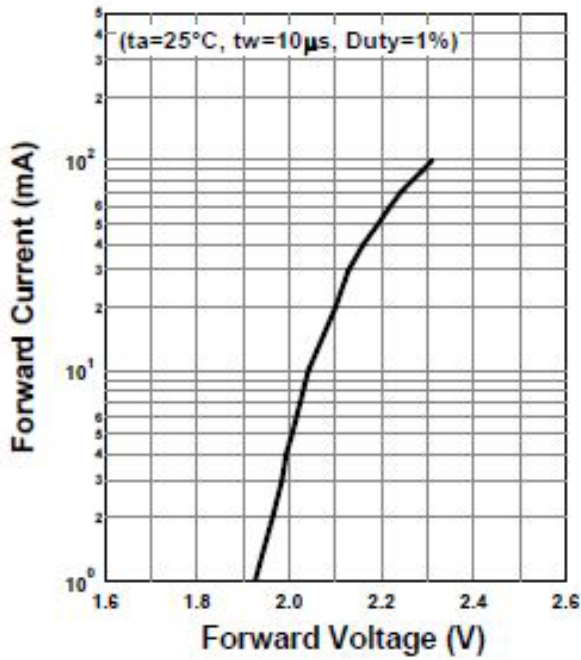

Relative Radiant Intensity - Forward Current

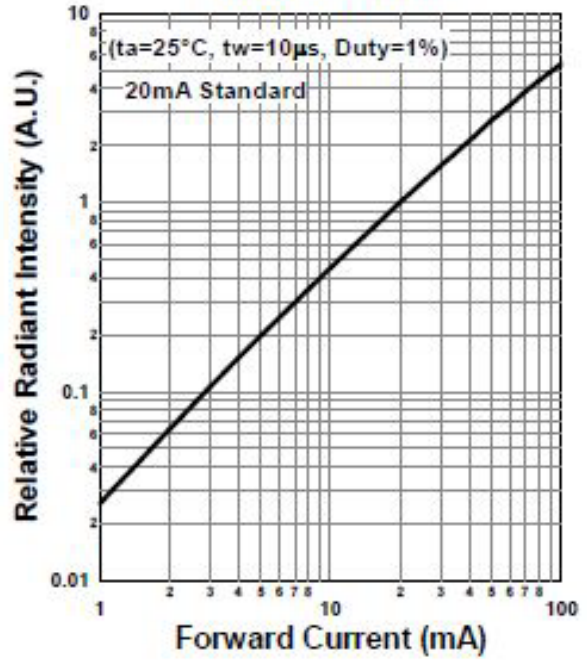

Forward Current - Pulse Duration

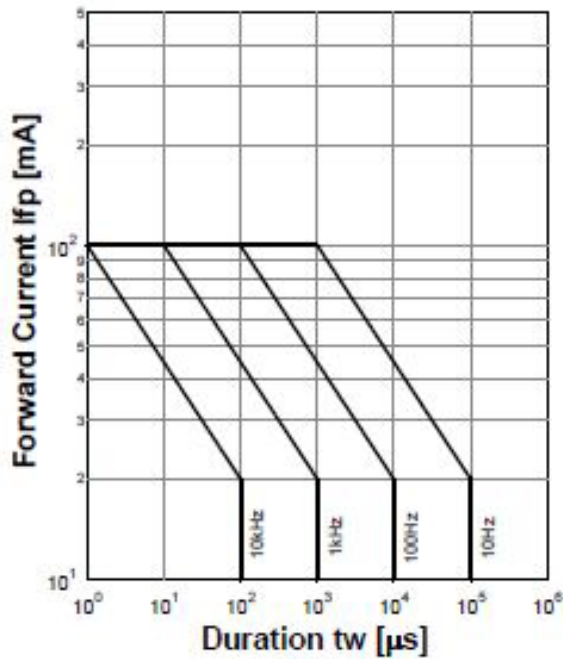

Allowable Forward Current - Ambient Temperature

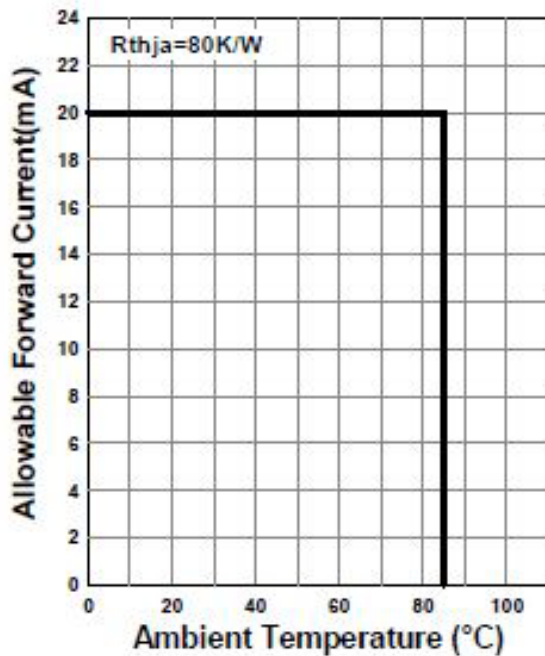

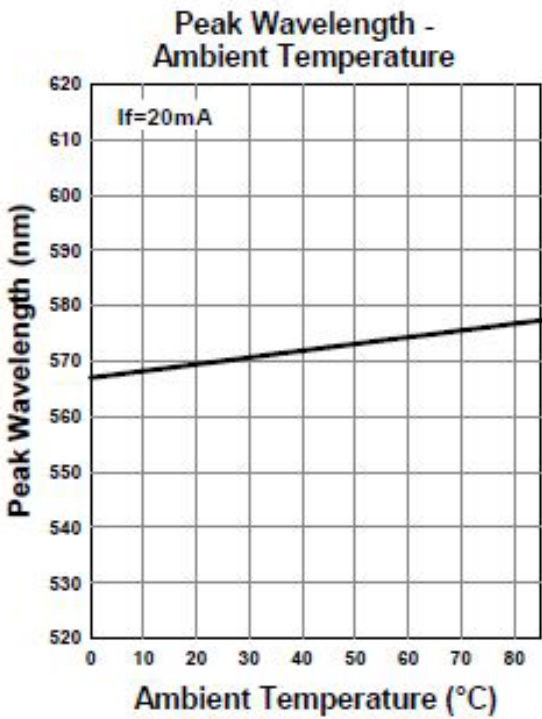
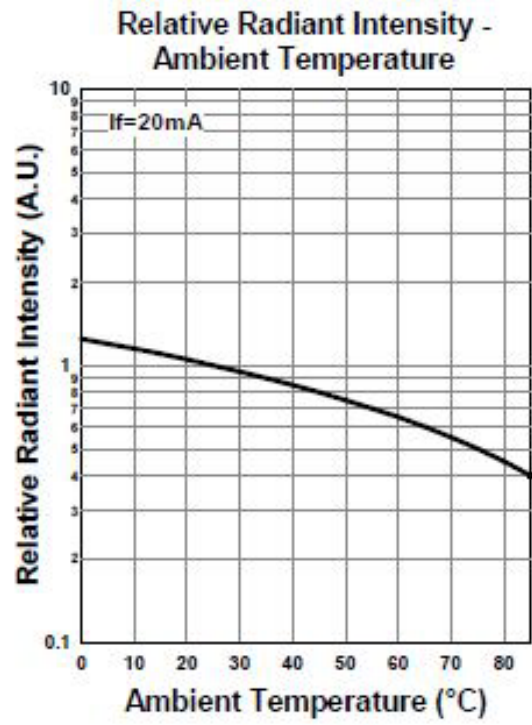
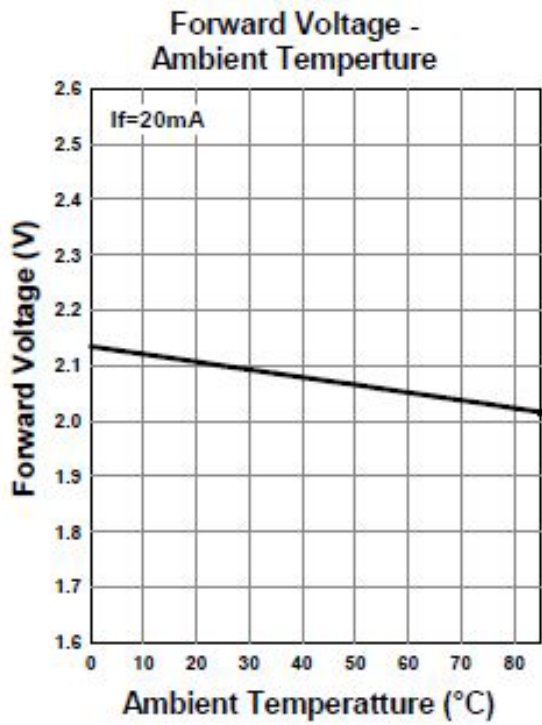

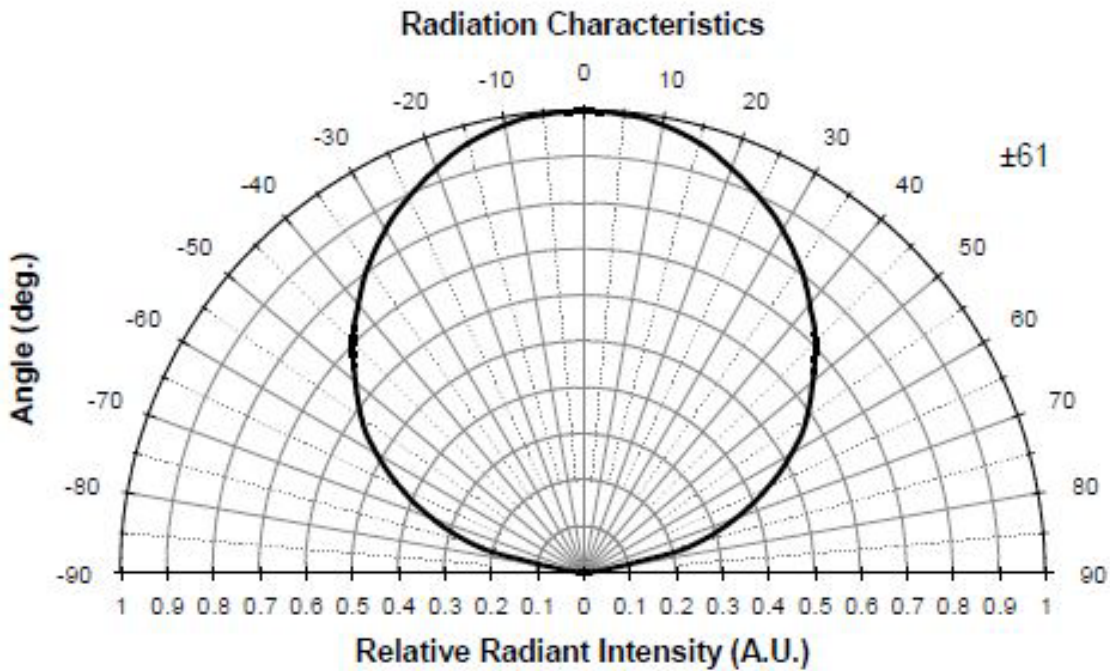
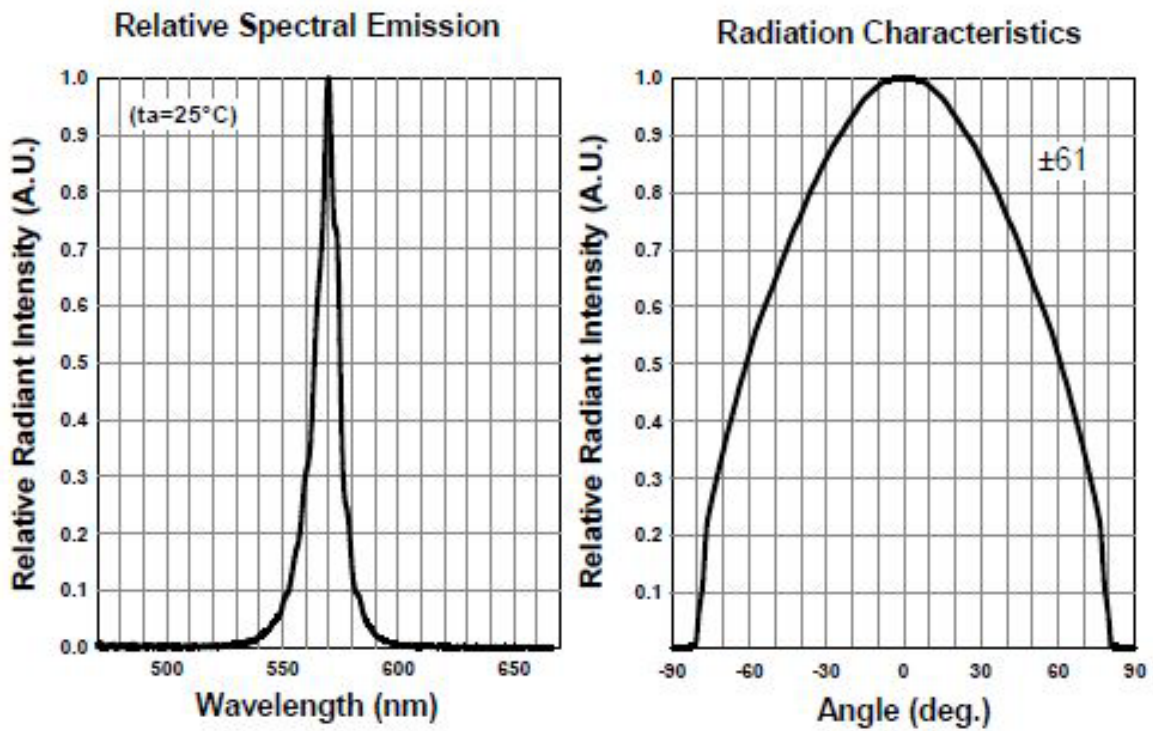

Wrapping

Moisture barrier bag aluminum laminated film with a desiccant to keep out the moisture absorption during the transportation and storage.

SMD LED storage and handling precautions

Storage Conditions before Opening a Moisture-Barrier Aluminum Bag

- Before opening a moisture-barrier aluminum bag, please store it at <30°C, <60%RH.
- Please note that the maximum shelf life is 12 months under these conditions.

Storage Conditions after Opening a Moisture-Barrier Aluminum Bag

- After opening a moisture-barrier aluminum bag, store the aluminum bag and silica gel in a desiccator.
- After opening the bag, please solder the LEDs within 72 hours in a room with 5 - 30°C, <50%RH.
- Please put any unused, remaining LEDs and silica gel back in the same aluminum bag and then vacuum-seal the bag.
- It is recommended to keep the re-sealed bag in a desiccator at <30%RH.
- The 72-hour- long floor life does not include the time while LEDs are stored in the moisture-barrier aluminum bag. However, we strongly recommend to solder the LEDs as soon as possible after opening the aluminum bag

Notes about Re-sealing a Moisture-Barrier Aluminum Bag

- When vacuum-sealing an opened aluminum bag, if you find the moisture-indicator of the silica gel has changed to pink from blue (indicating a relative humidity of 30 % or more), please do not use the unused LEDs, the aluminum bag, or the silica gel.

Notes about Opening a Re-sealed Moisture-Barrier Aluminum Bag

- When opening a vacuumed and re-sealed aluminum bag in order to use the remaining LEDs stored in the bag, if you find that the moisture-indicator of the silica has changed to pink, please do not use the LEDs.

Disclaimer

Product specifications and data shown in this product catalog are subject to change without notice for the purposes of improving product performance, reliability, design, or otherwise.

Product data and parameters in this catalog are typical values based on reasonably up-to-date measurements.

Product data and parameters may vary by user application and over time.

Products shown in this catalog are intended to be used for general electronic equipment. Products are not guaranteed for applications where product malfunction or failure may cause personal injury or death, including but not limited to life-supporting / saving devices, medical devices, safety devices, airplanes, aerospace equipment, automobiles, traffic control systems, and nuclear reactor control systems.