

L690D-66-60
Infrared Illuminator

PRELIMINARY

<Specifications>

- Chip Material: AlGaInP
- Chip Dimension: 350um x 350um
- Number of Chips: 60pcs
- Peak Wavelength: 690nm typ.
- Stem: TO-66 Stem
- Lens: Silicone and/or Epoxy Resin

Outer Dimension (Unit:mm)

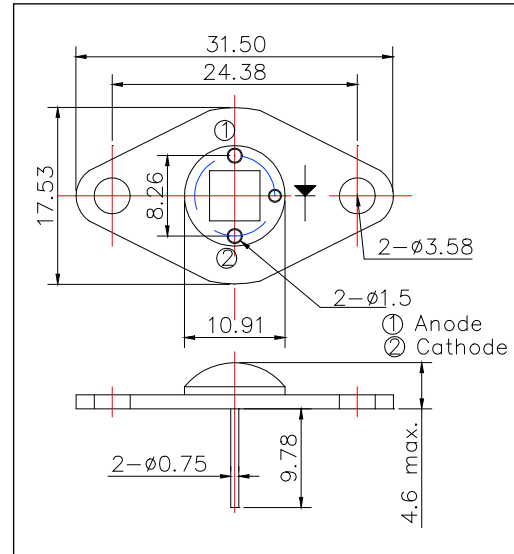

Absolute Maximum Ratings [Tc=25°C]			
Item	Symbol	Value	Unit
Power Dissipation	PD	7.2	W
Forward Current	IF	600	mA
Reverse Voltage	VR	25	V
Thermal Resistance	Rthja	2	K/W
Junction Temperature	Tj	120	°C
Operating Temperature	TOPR	-40 ~ +85	°C
Storage Temperature	TSTG	-40 ~ +100	°C
Soldering Temperature*	TSOL	265	°C

* Soldering condition must be completed within 3 second at 265°C.

Electro-Optical Characteristics [Tc=25°C]						
Item	Symbol	Condition	Minimum	Typical	Maximum	Unit
Forward Voltage	VF	IF=240mA		9.5	12	V
Total Radiated Power*	PO	IF=240mA		470		mW
Peak Wavelength	λP	IF=240mA	680		700	nm
Half Width	Δλ	IF=240mA		16		nm
Viewing Half Angle	θ1/2	IF=100mA		±24		deg
Rise Time	tr	IF=240mA		40		ns
Fall Time	tf	IF=240mA		30		ns

* Measured by S3584-08



Typical Characteristic Curves

Forward Current - Forward Voltage

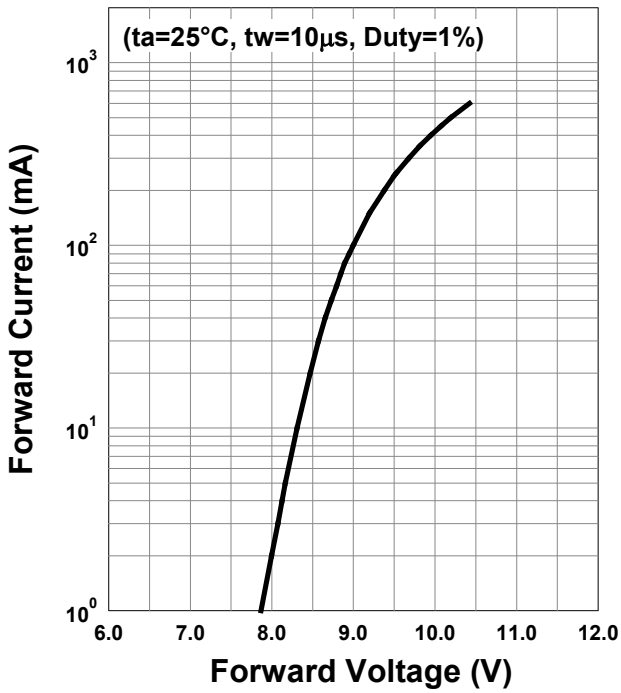

Relative Radiant Intensity - Forward Current

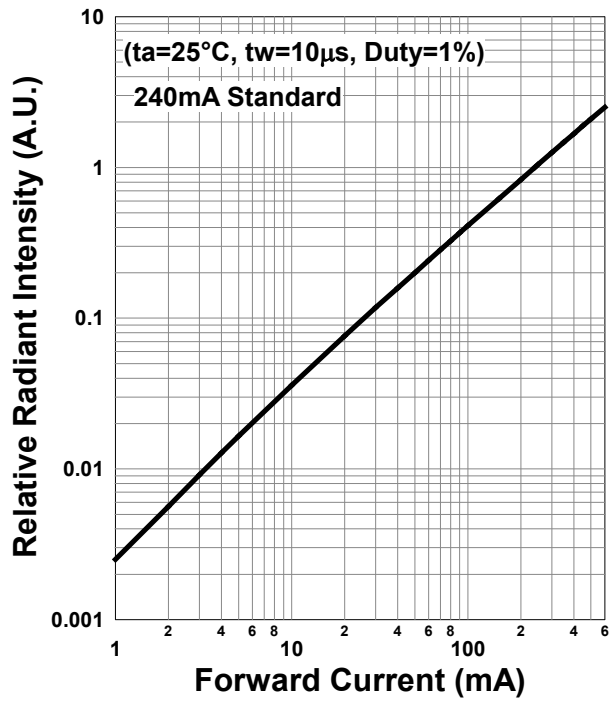

Allowable Forward Current - Ambient Temperature

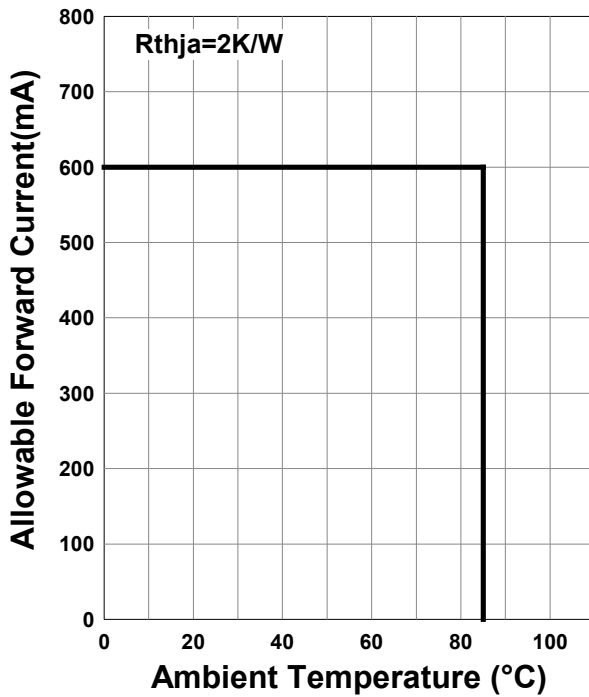

Radiation Characteristics

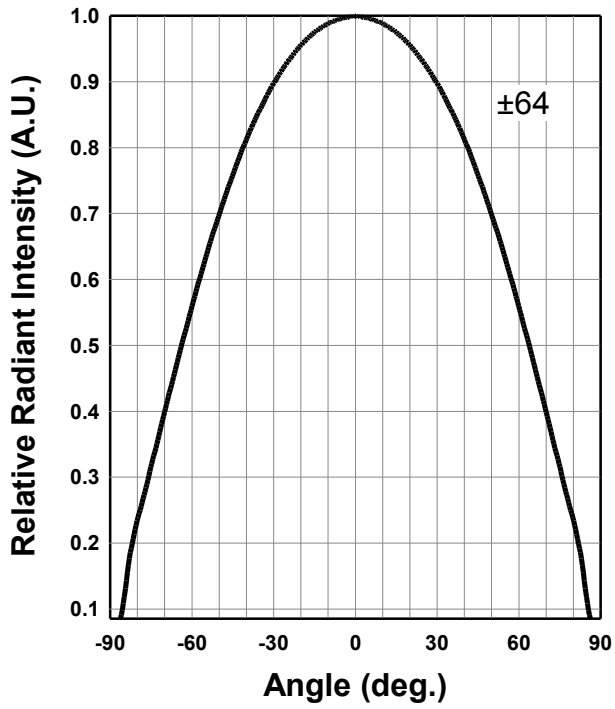

Radiation Characteristics

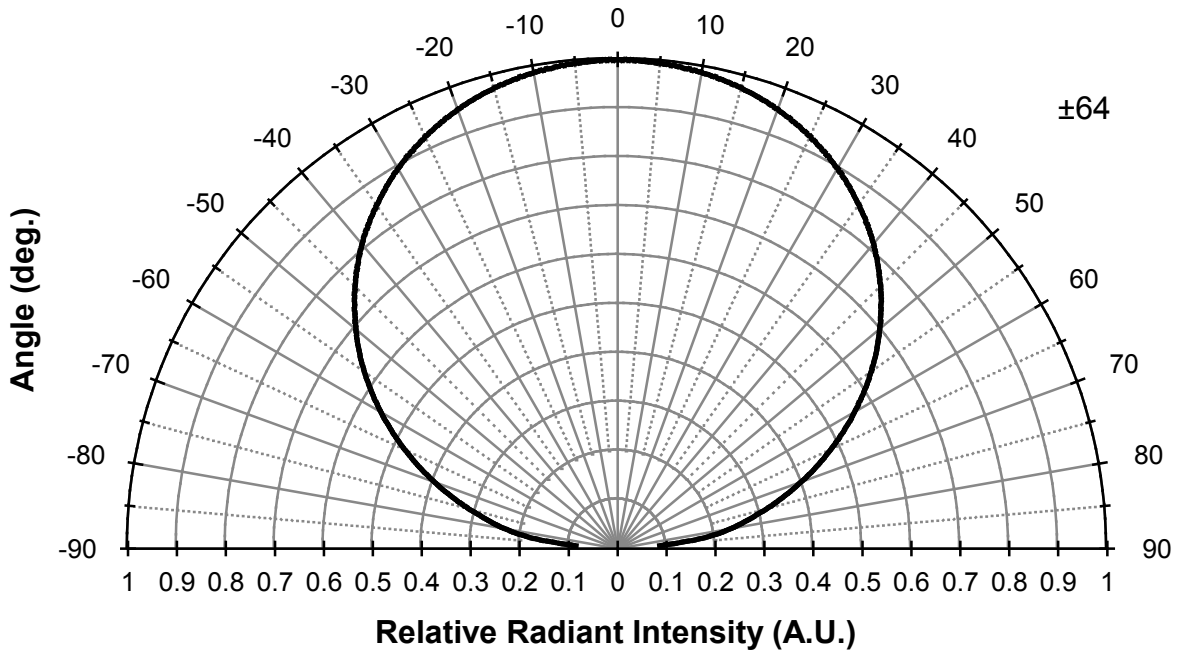

*The data below shows the characteristics of one representative TO-66 chip.

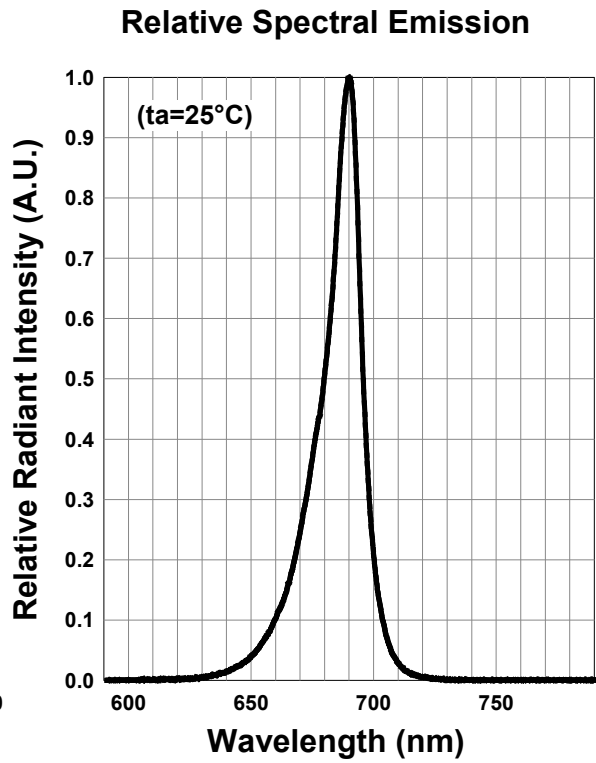
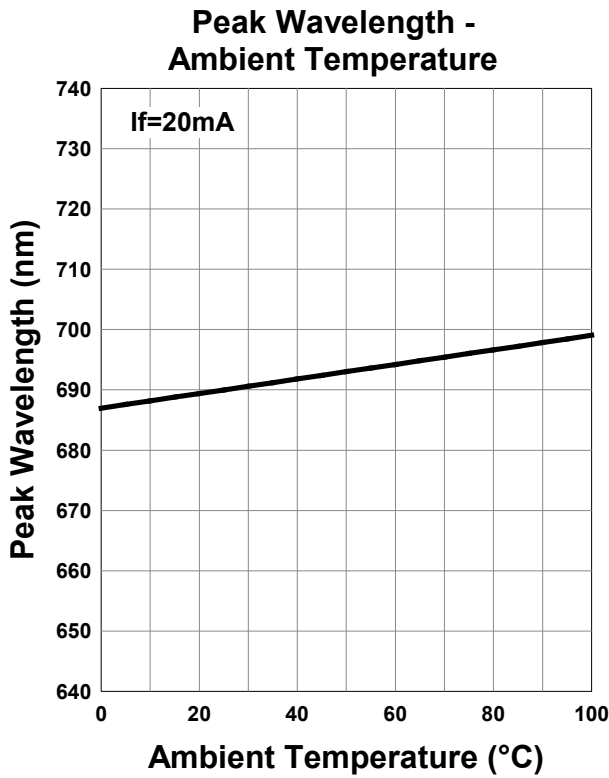
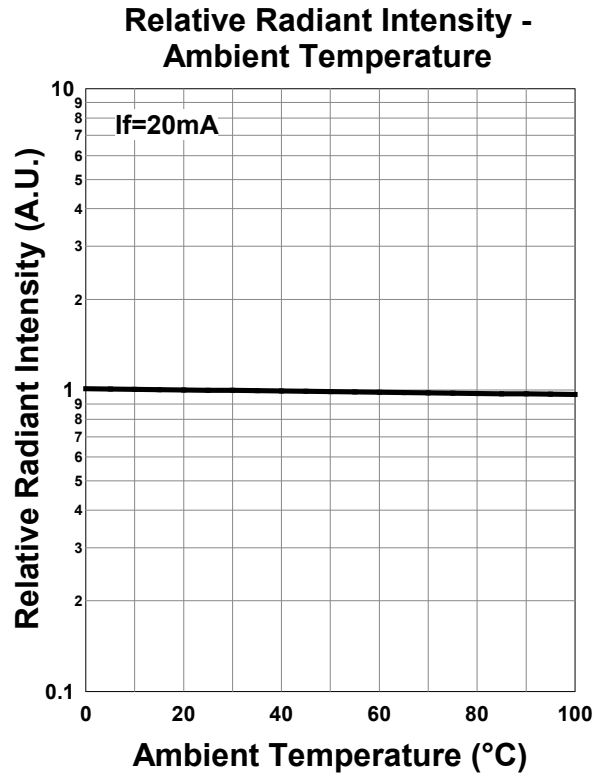
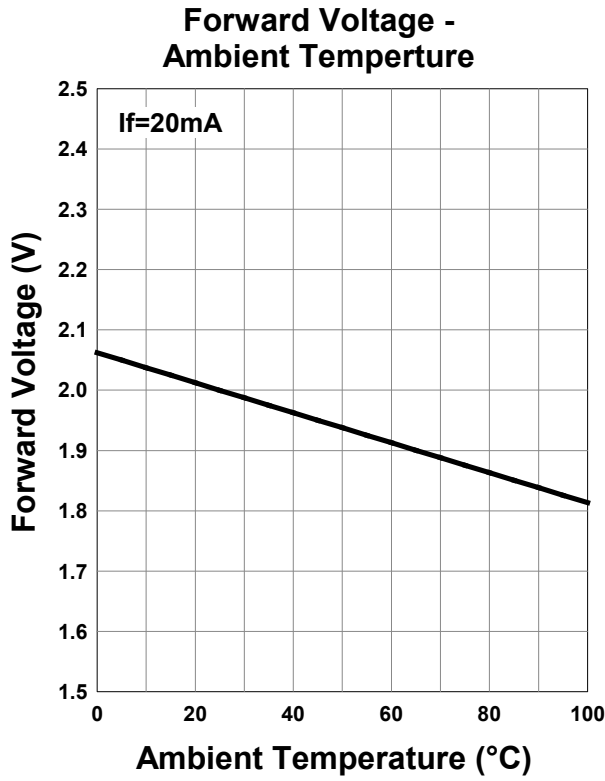

Disclaimer

Product specifications and data shown in this product catalog are subject to change without notice for the purposes of improving product performance, reliability, design, or otherwise.

Product data and parameters in this catalog are typical values based on reasonably up-to-date measurements.

Product data and parameters may vary by user application and over time.

Products shown in this catalog are intended to be used for general electronic equipment. Products are not guaranteed for applications where product malfunction or failure may cause personal injury or death, including but not limited to life-supporting / saving devices, medical devices, safety devices, airplanes, aerospace equipment, automobiles, traffic control systems, and nuclear reactor control systems.