

L1600-35K42
Stem Type LED Lamp

<Specifications>

- Chip Material: InGaAsP
- Chip Dimension: 300um x 300um
- Number of Chips: 1pcs
- Peak Wavelength: 1600nm typ.
- Stem: TO-46 type
- Lens: Unspherical Glass
- CAP: Gold Plated

Outer Dimension (Unit:mm)

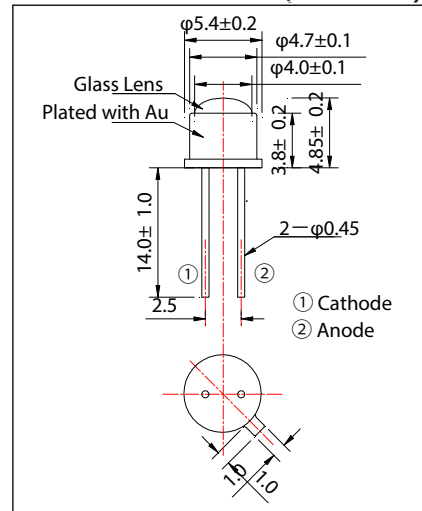

Absolute Maximum Ratings [Tc=25°C]			
Item	Symbol	Value	Unit
Power Dissipation	PD	130	mW
Forward Current	IF	100	mA
Pulse Forward Current*	IFP	1000	mA
Reverse Voltage	VR	5	V
Thermal Resistance	Rthja	300	K/W
Junction Temperature	Tj	120	°C
Operating Temperature	TOPR	-40 ~ +100	°C
Storage Temperature	TSTG	-40 ~ +100	°C
Soldering Temperature**	TSOL	250	°C

*Duty=1% and Pulse Width=10μs.

**Soldering condition must be completed within 3 second at 250°C.

Electro-Optical Characteristics [Tc=25°C]						
Item	Symbol	Condition	Min	Typ	Max	Unit
Forward Voltage	VF	IF=50mA		0.9	1.3	V
	VFP	IFP=1A		1.7		
Total Radiated Power*	PO	IF=50mA		2.0		mW
		IFP=1A		10		
Radiant Intensity**	IE	IF=50mA		27		mW/sr
		IFP=1A		130		
Peak wavelength	λP	IF=50mA	1550		1650	nm
Half Width	Δλ	IF=50mA		125		nm
Viewing Half Angle	θ1/2	IF=50mA		±10		deg
Rise Time	tr	IF=50mA		80		ns
Fall Time	tf	IF=50mA		30		ns

* Measured by G8370-85

** Measured by Ando Optical Multi Meter AQ2140&AQ2742

Forward Current - Forward Voltage

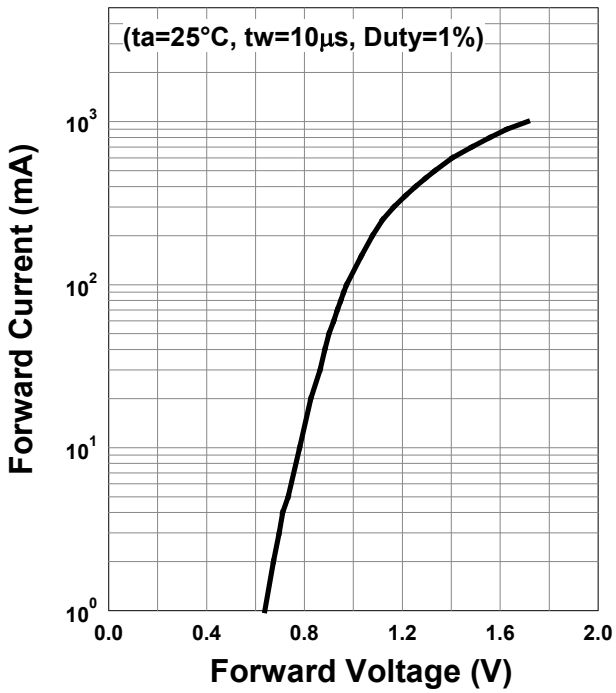

Relative Radiant Intensity - Forward Current

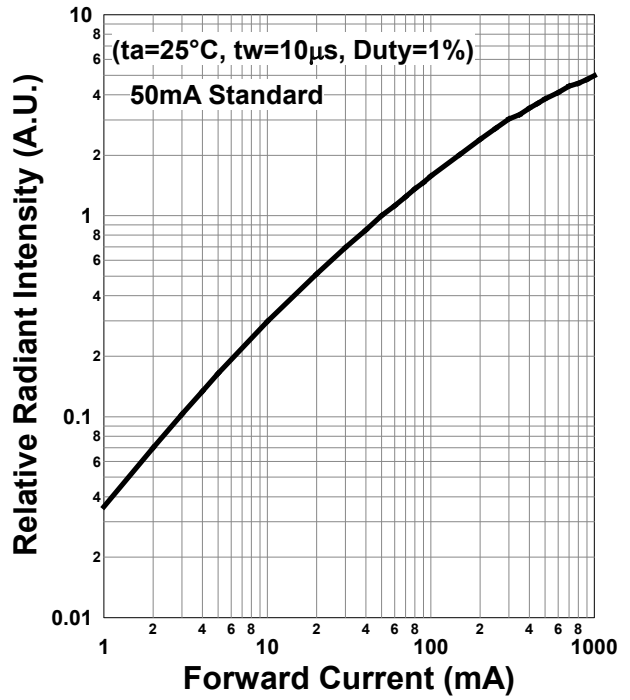

Forward Current - Pulse Duration

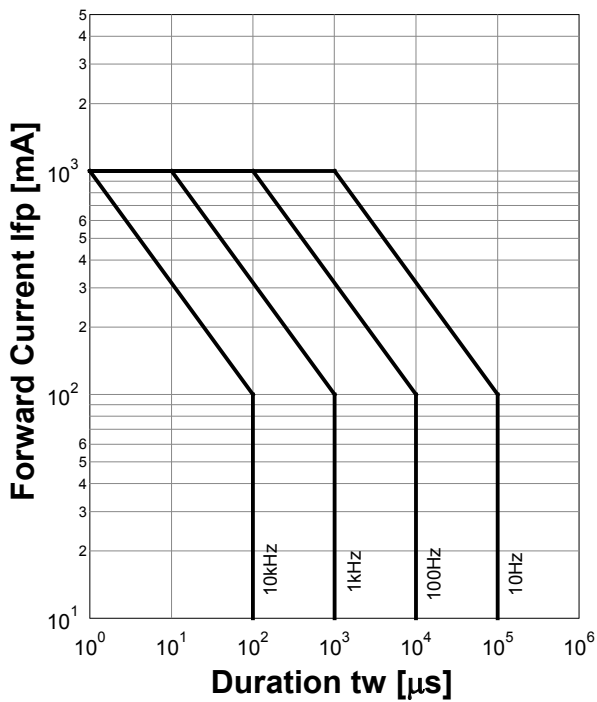

Allowable Forward Current - Ambient Temperature

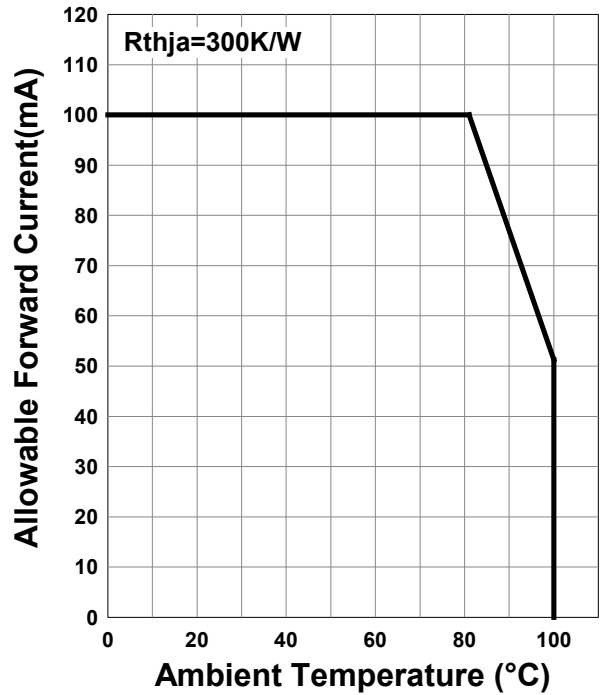

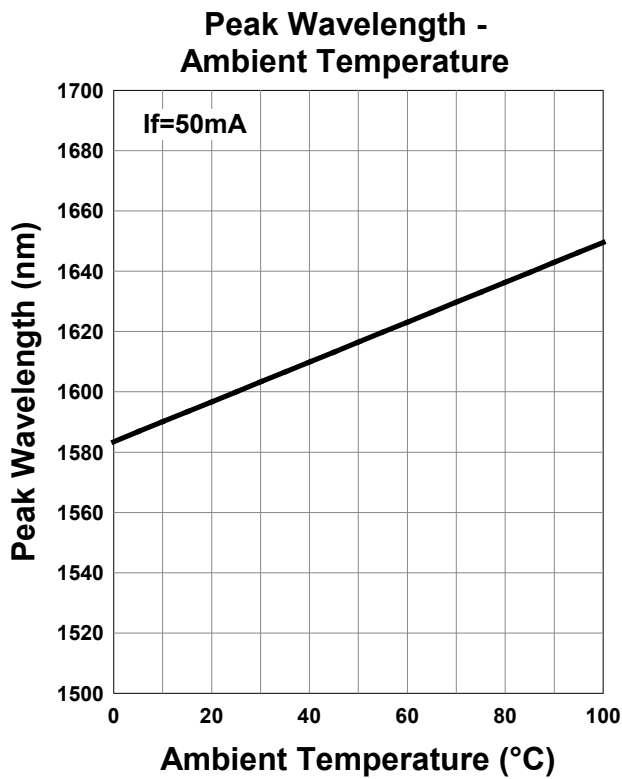
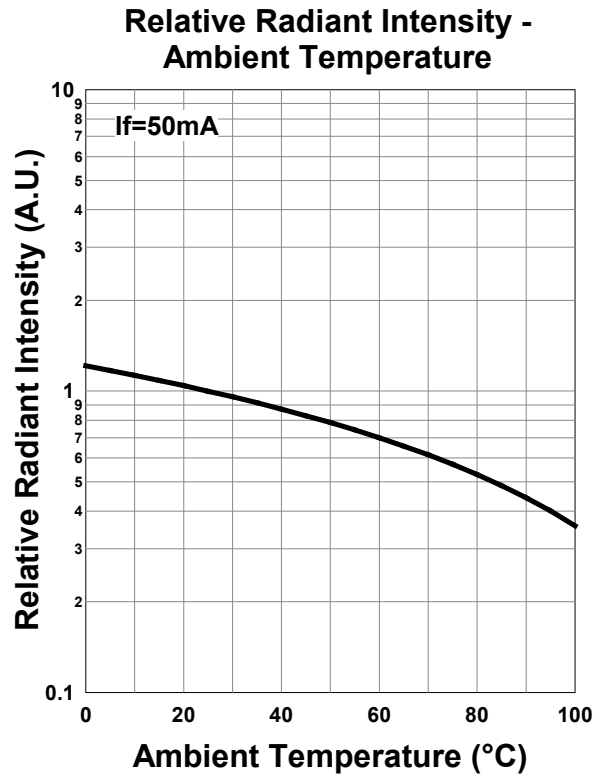
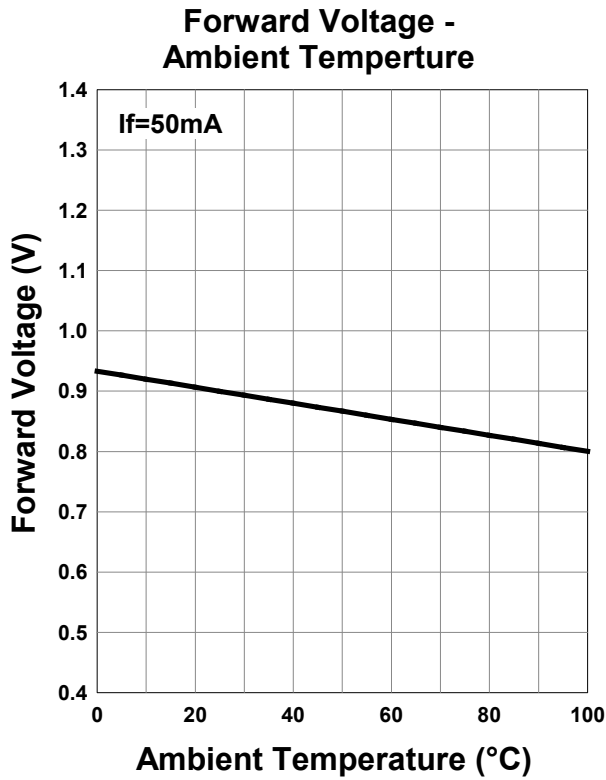

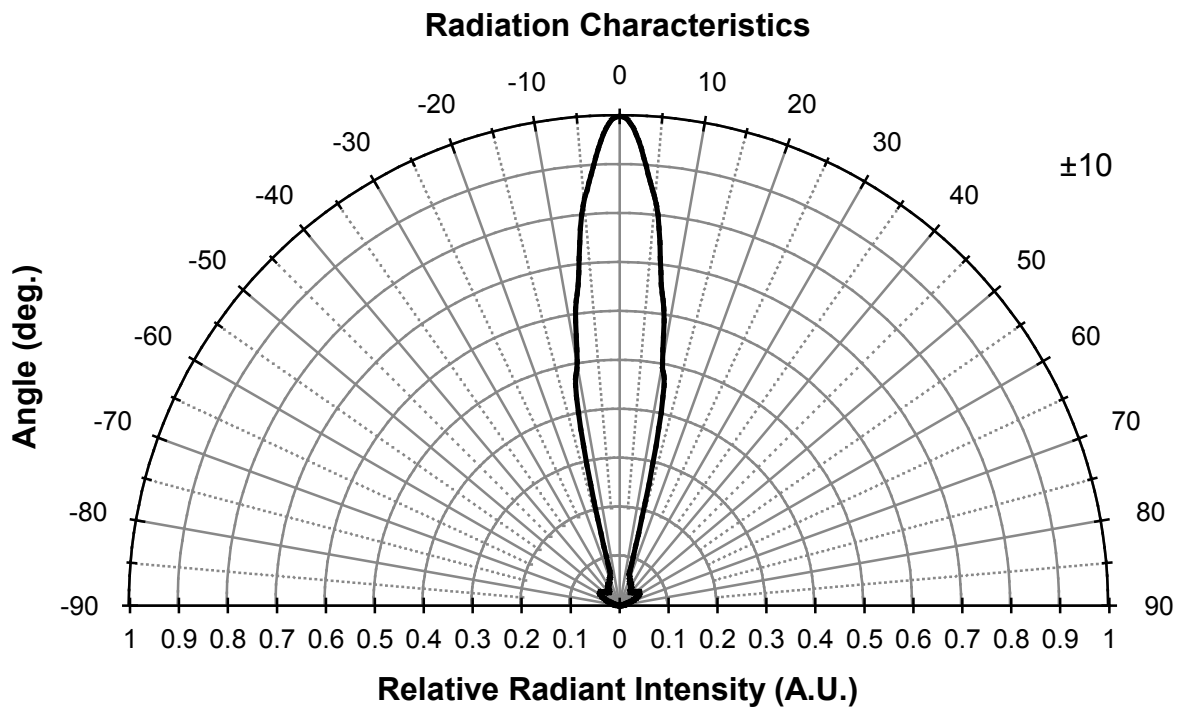
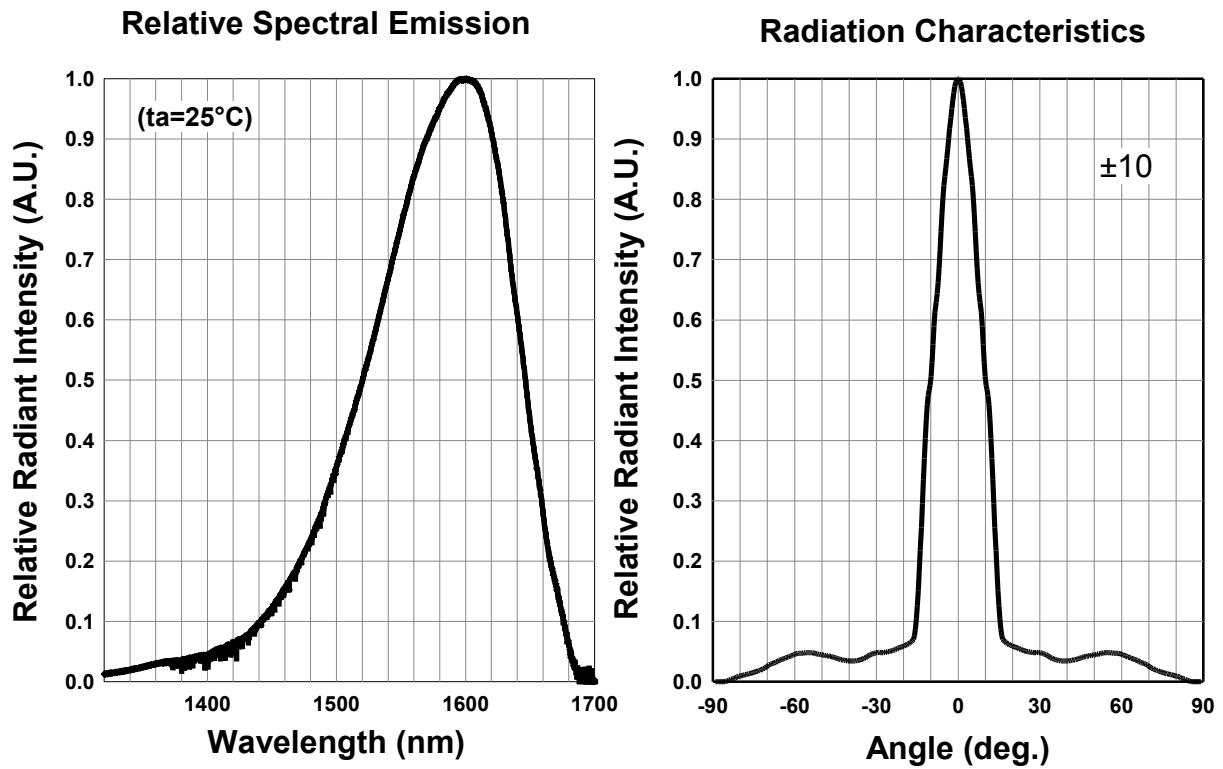

Disclaimer

Product specifications and data shown in this product catalog are subject to change without notice for the purposes of improving product performance, reliability, design, or otherwise.

Product data and parameters in this catalog are typical values based on reasonably up-to-date measurements.

Product data and parameters may vary by user application and over time.

Products shown in this catalog are intended to be used for general electronic equipment. Products are not guaranteed for applications where product malfunction or failure may cause personal injury or death, including but not limited to life-supporting / saving devices, medical devices, safety devices, airplanes, aerospace equipment, automobiles, traffic control systems, and nuclear reactor control systems.

2017.06