

L910-40K00

Stem Type LED with Epoxy Resin Lens

L910-40K00 is an AlGaAs LED mounted on a TO-46 stem with an epoxy resin lens. It is designed for wide viewing angle.

On forward bias, it emits a spectral band of radiation which peaks at 910nm.

<Features>

- Wide Viewing Angle
- High Reliability

<Specifications>

1. Product Name: Infrared LED Lamp
2. Type Number: L910-40K00
3. Chip:
 - Chip material: AlGaAs
 - Peak Wavelength: 910nm
4. Package
 - Type: TO-46 Stem
 - Lens: Epoxy Resin Lens
 - Cap: Gold Plated

Outer Dimension (Unit:mm)

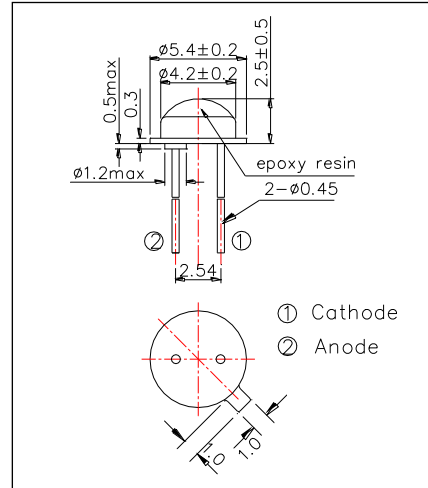

Absolute Maximum Ratings				
Item	Symbol	Maximum Rated Value	Unit	Ambient Temperature
Power Dissipation	PD	160	mW	Ta=25°C
Forward Current	IF	100	mA	Ta=25°C
Pulse Forward Current*	IFP	500	mA	Ta=25°C
Reverse Voltage	VR	5	V	Ta=25°C
Operating Temperature	TOPR	-30 ~ +80	°C	
Storage Temperature	TSTG	-30 ~ +100	°C	
Soldering Temperature**	TSOL	260	°C	

* Duty=1% and Pulse Width=10μs.

** Soldering condition must be completed within 3 second at 260 °C.

Electro-Optical Characteristics [Ta=25°C]						
Item	Symbol	Condition	Minimum	Typical	Maximum	Unit
Forward Voltage	VF	IF=50mA		1.45	1.70	V
Reverse Current	IR	VR=5V			10	uA
Total Radiated Power*	PO	IF=50mA	5	8		mW
Radiant Intensity**	IE	IF=50mA		2		mW/sr
Peak Wavelength	λP	IF=50mA	900	910	925	nm
Half Width	Δλ	IF=50mA		60		nm
Viewing Half Angle	θ1/2	IF=50mA		±60		deg
Rise Time	tr	IF=50mA		1000		ns
Fall Time	tf	IF=50mA		400		ns

* Measured by Photodyne #500

** Measured by Tektronix J-6512

