

L940D-05
Infrared LED Lamp

<Specifications>

- Chip Material: AlGaAs
- Peak Wavelength: 940nm typ.
- Package Type: Φ3mm Clear Molding
- Lead Frame: Soldered(Lead Free)
- Lens: Epoxy Resin

Outer Dimension (Unit:mm)

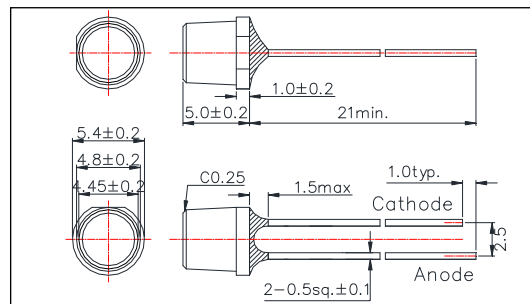

Absolute Maximum Ratings[Ta=25°C]			
Item	Symbol	Maximum Rated Value	Unit
Power Dissipation	PD	170	mW
Forward Current	IF	100	mA
Pulse Forward Current*	IFP	1000	mA
Reverse Voltage	VR	5	V
Junction Temperature	Tj	120	°C
Thermal Resistance	Rthja	170	K/W
Operating Temperature	TOPR	-40 ~ +100	°C
Storage Temperature	TSTG	-40 ~ +100	°C
Soldering Temperature**	TSOL	265	°C

*Duty=1% and Pulse Width=10us.

** Soldering condition must be completed within 3seconds at 265°C.

Electro-Optical Characteristics [Ta=25°C]						
Item	Symbol	Condition	Minimum	Typical	Maximum	Unit
Forward Voltage	VF	IF=50mA		1.4	1.7	V
	VFP	IFP=1A		2.1		
Total Radiated Power*	PO	IF=50mA		25		mW
		IFP=1A		400		
Radiant Intensity**	IE	IF=50mA		9.3		mW/sr
		IFP=1A		150		
Peak Wavelength	λP	IF=50mA	930		955	nm
Half Width	Δλ	IF=50mA		40		nm
Viewing half Angle	θ1/2	IF=50mA		±45		deg
Rise Time	tr	IF=50mA		1000		ns
Fall Time	tf	IF=50mA		1000		ns

* Measured by S3584-08

** Measured by CIE127-2007 Condition B.



Typical Characteristic Curves

Forward Current - Forward Voltage

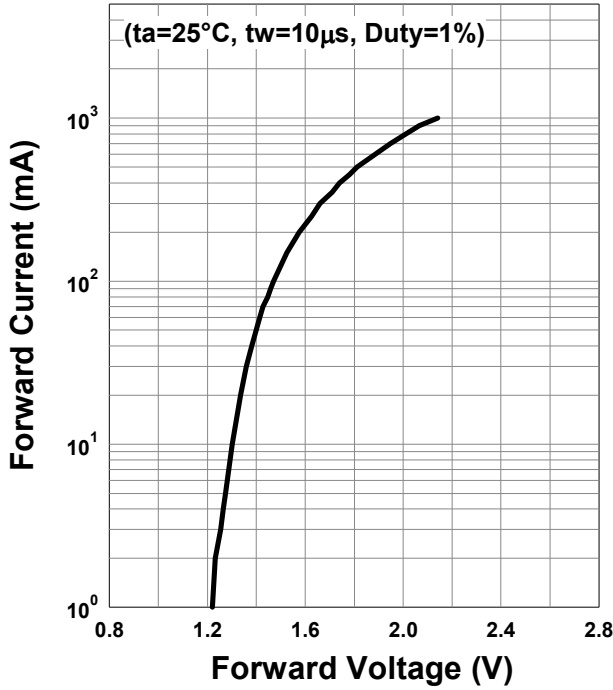

Relative Radiant Intensity - Forward Current

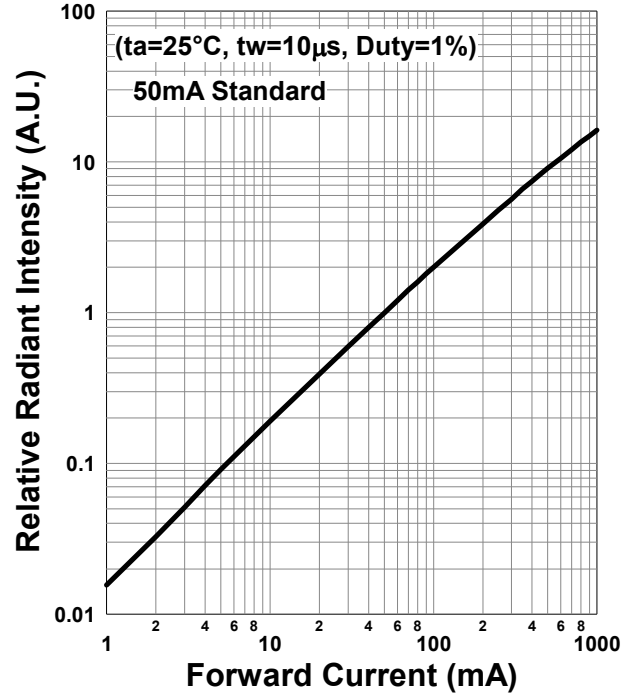

Forward Current - Pulse Duration

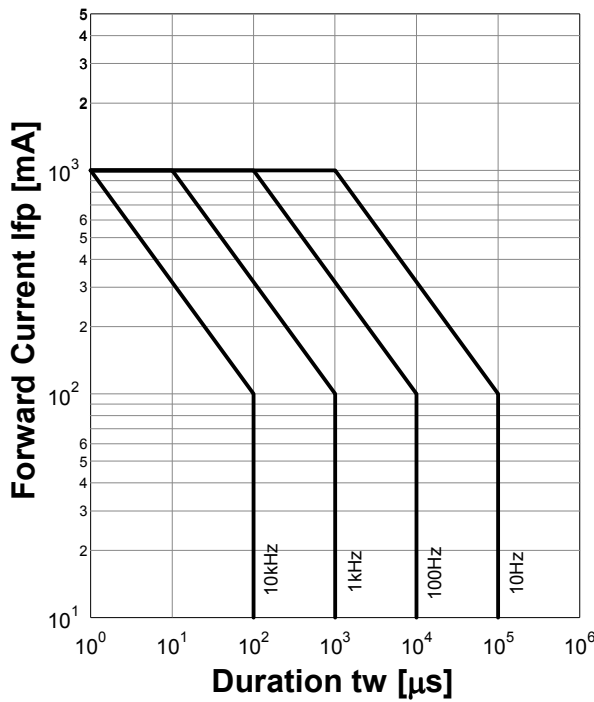

Allowable Forward Current - Ambient Temperature

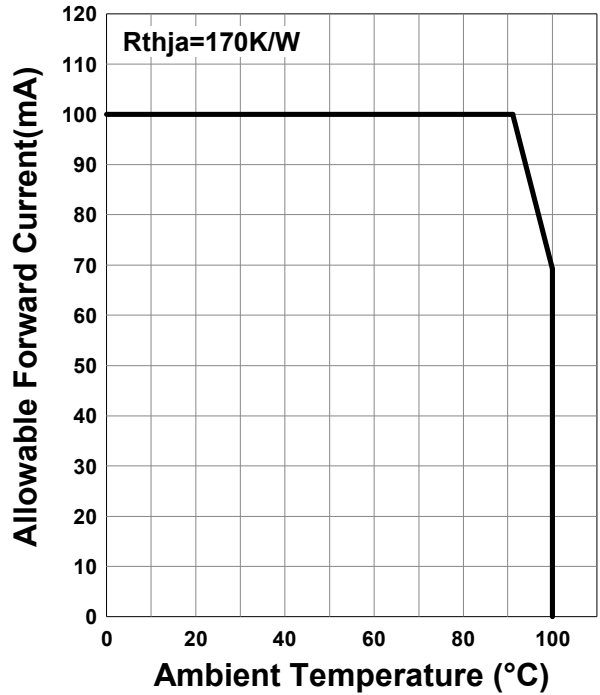

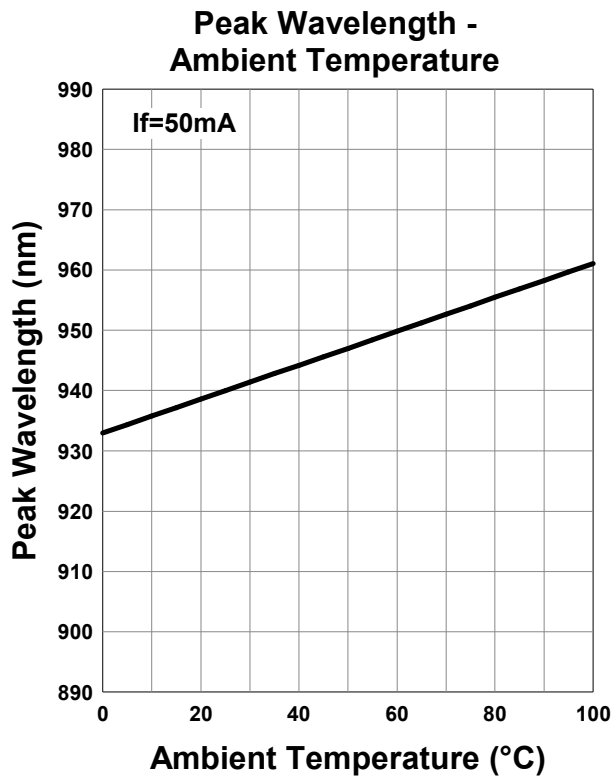
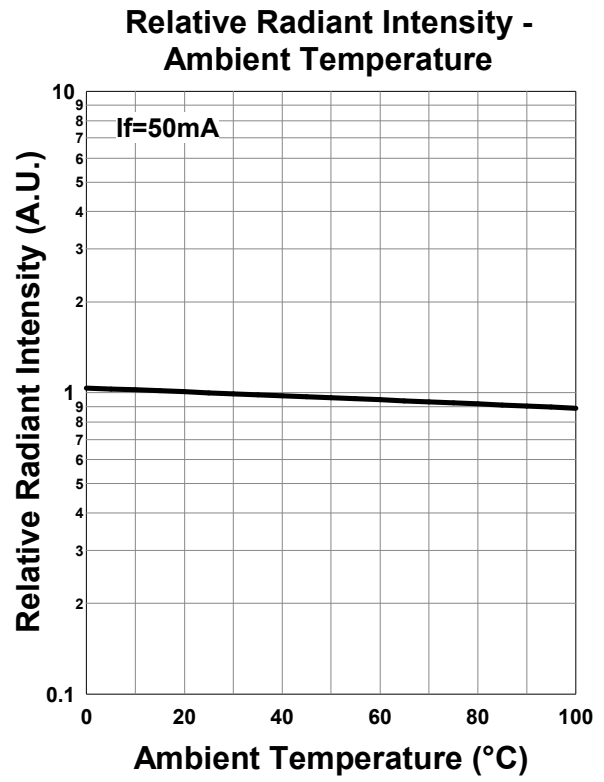
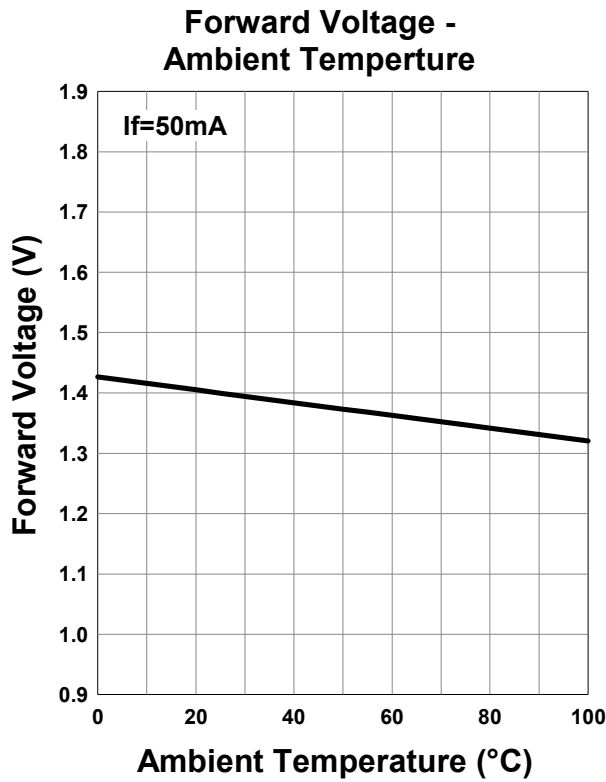

Relative Spectral Emission

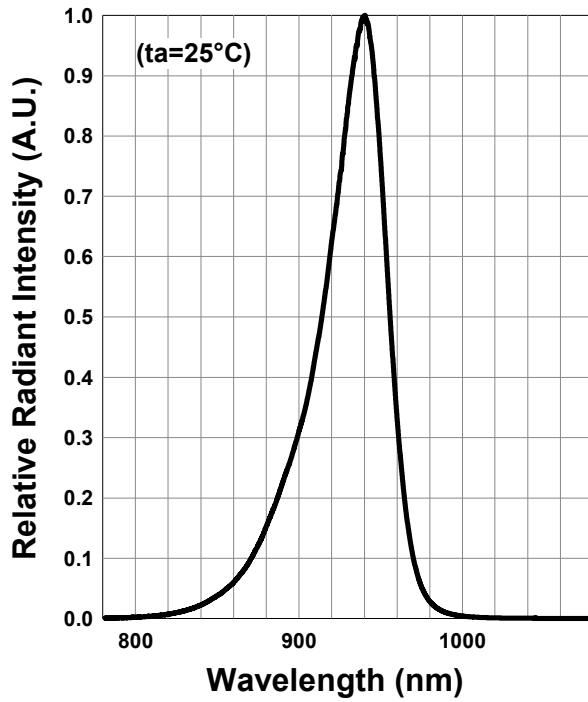

Radiation Characteristics

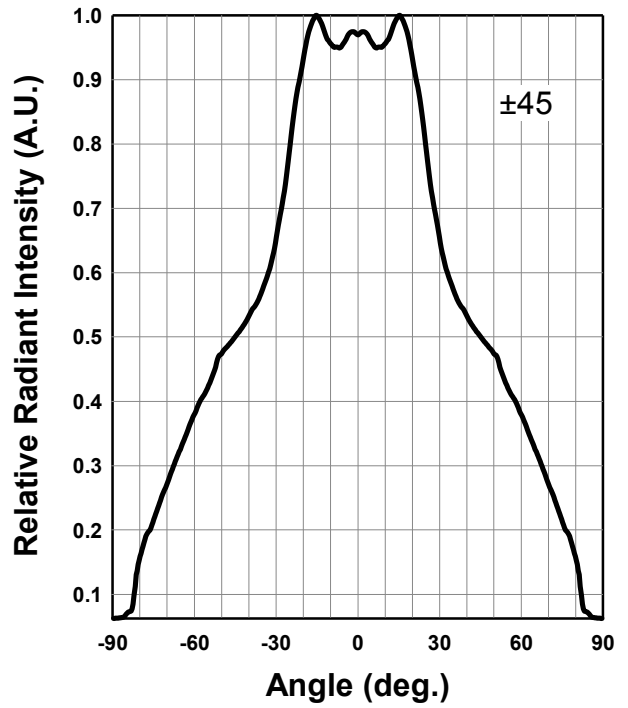

Radiation Characteristics

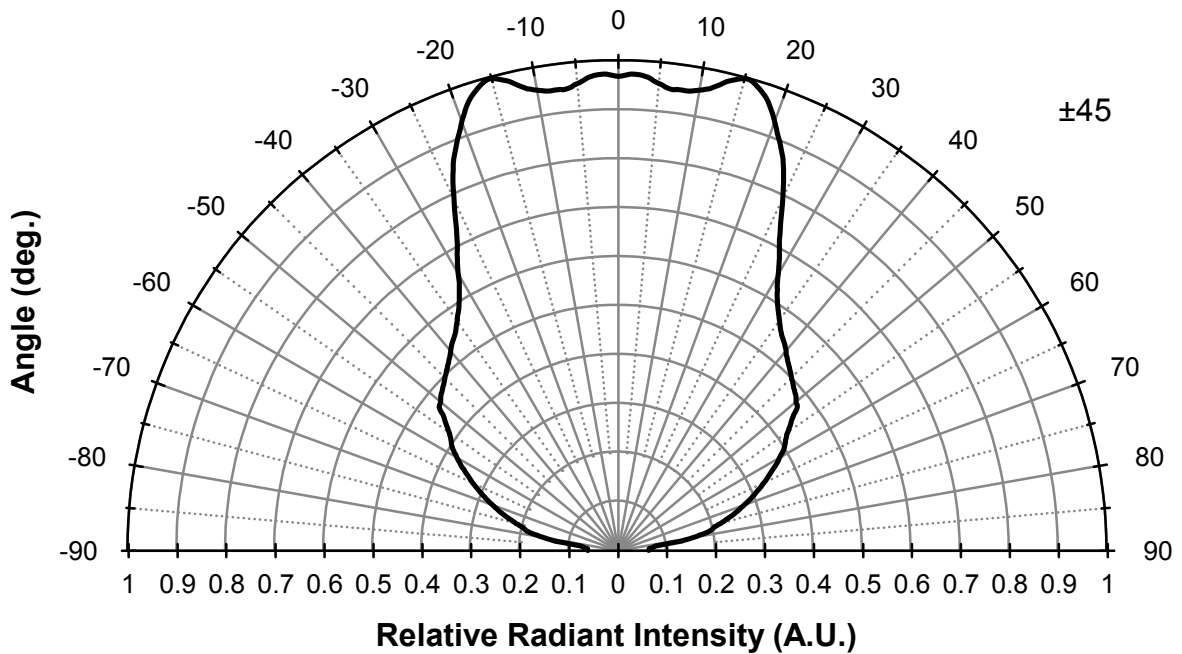

Disclaimer

Product specifications and data shown in this product catalog are subject to change without notice for the purposes of improving product performance, reliability, design, or otherwise.

Product data and parameters in this catalog are typical values based on reasonably up-to-date measurements.

Product data and parameters may vary by user application and over time.

Products shown in this catalog are intended to be used for general electronic equipment. Products are not guaranteed for applications where product malfunction or failure may cause personal injury or death, including but not limited to life-supporting / saving devices, medical devices, safety devices, airplanes, aerospace equipment, automobiles, traffic control systems, and nuclear reactor control systems.