

Cute-3-OSL (MR11), lenses for Osram Oslon SSL LEDs

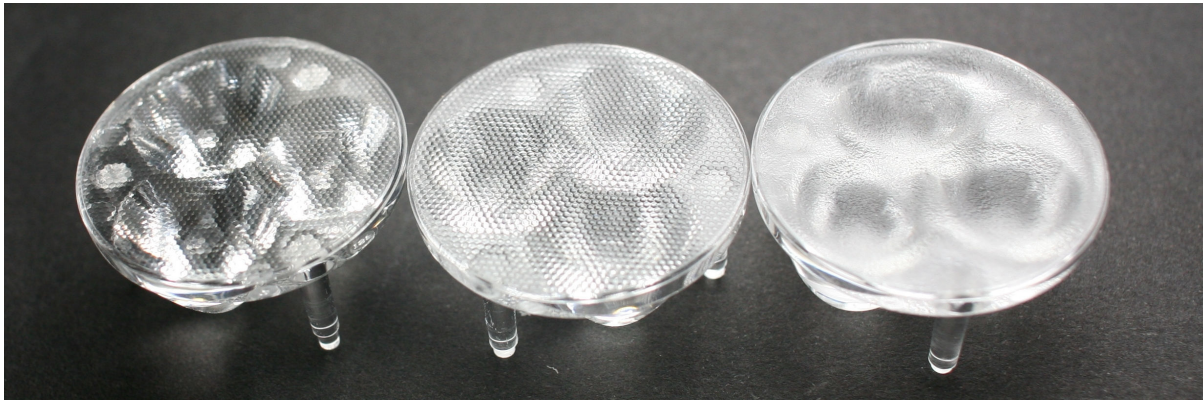

- Specially designed for Osram Oslon SSL series of LEDs.
- Special care taken to make a uniform white or warm white illumination. Lenses work well with other colors, too.
- Lens material optical grade PMMA. Allows use of high current and temperature conditions
- No lens holder. Fastening to heat sink with droplets of glue.
- Best available optical efficiency, up to 90%.

LENS TYPES

NAME	ORDERING CODE	FWHM Angle
Cute-3 Smooth Spot	C10754_Cute-3-SS-OSL	±5°
Cute-3 Medium	C10755_Cute-3-M-OSL	±11°
Cute-3 Wide	C10756_Cute-3-W-OSL	±20°

© Ledil Oy – PRELIMINARY - Subject to change without prior notice

MEASUREMENT DATA

Relative Intensity of C10754_Cute-3-SS-OSL

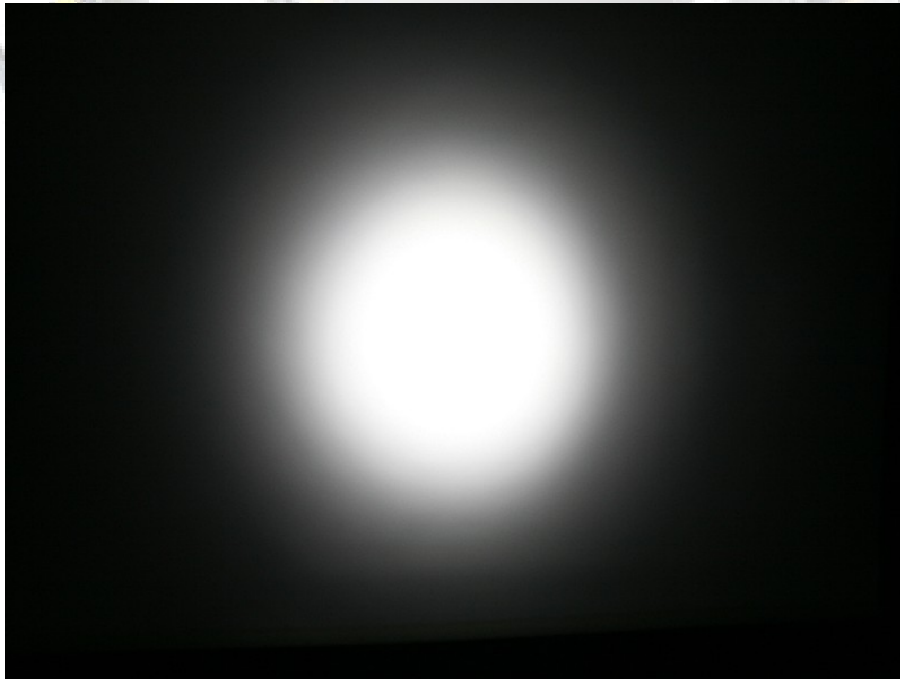
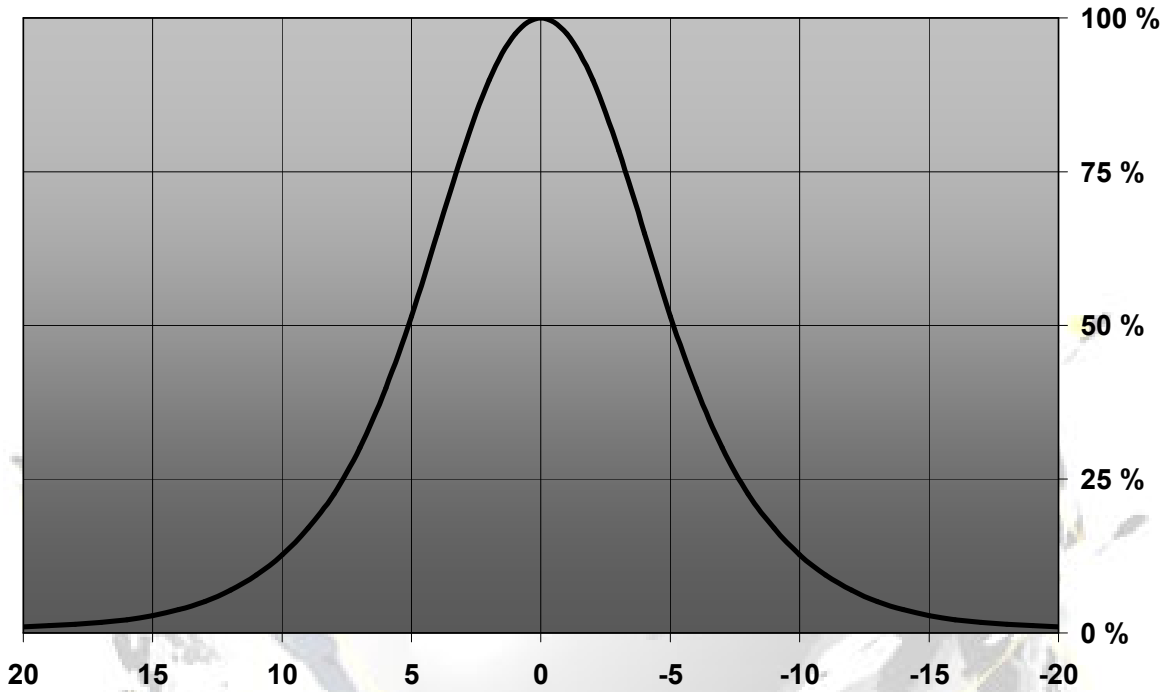

© Ledil Oy – PRELIMINARY - Subject to change without prior notice

Relative Intensity of C10755_Cute-3-M-OSL

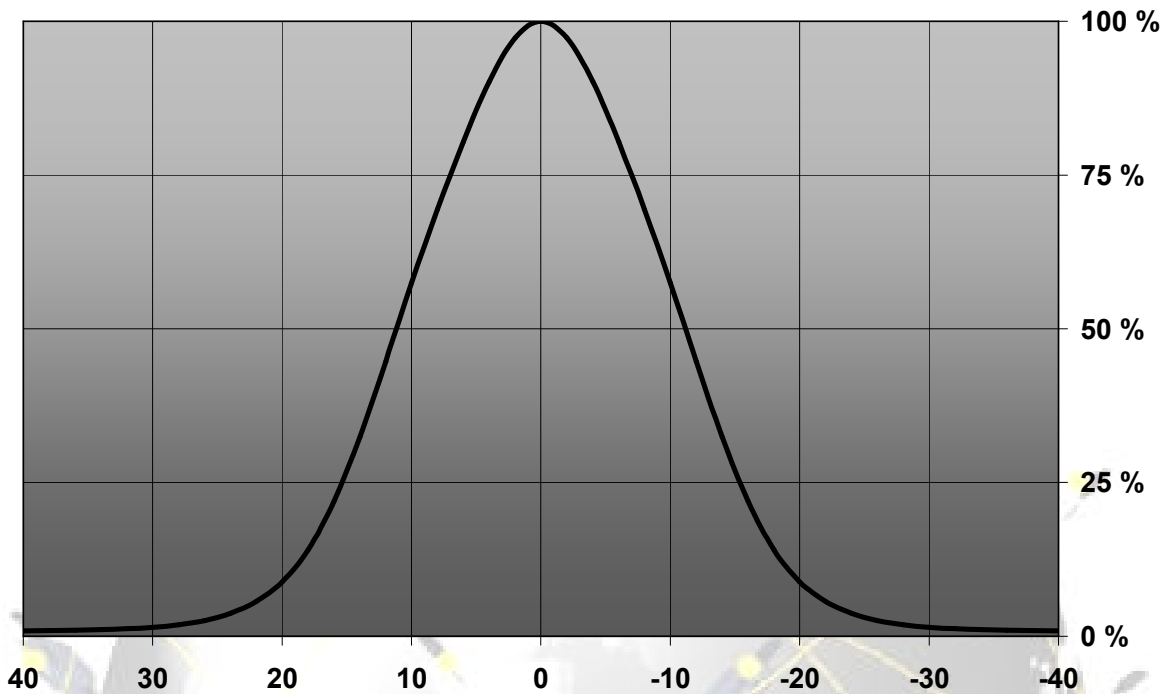

© Ledil Oy – PRELIMINARY - Subject to change without prior notice

Relative Intensity of C10756_Cute-3-ISF-W-OSL

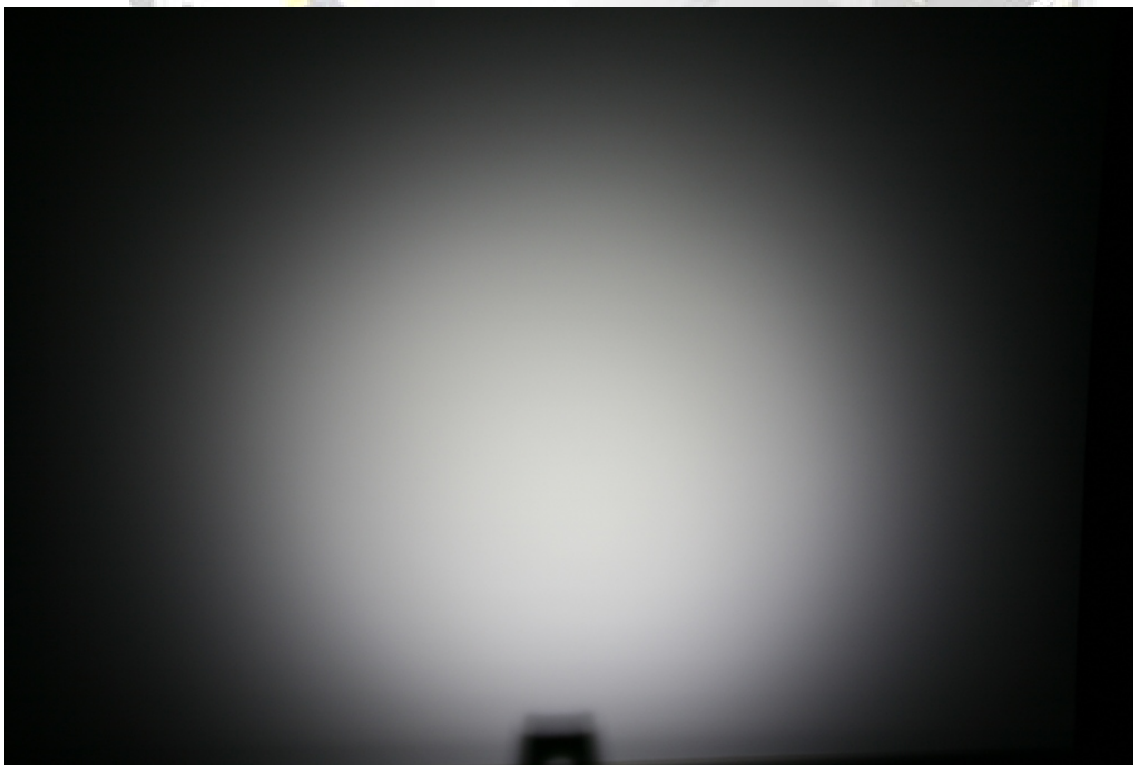
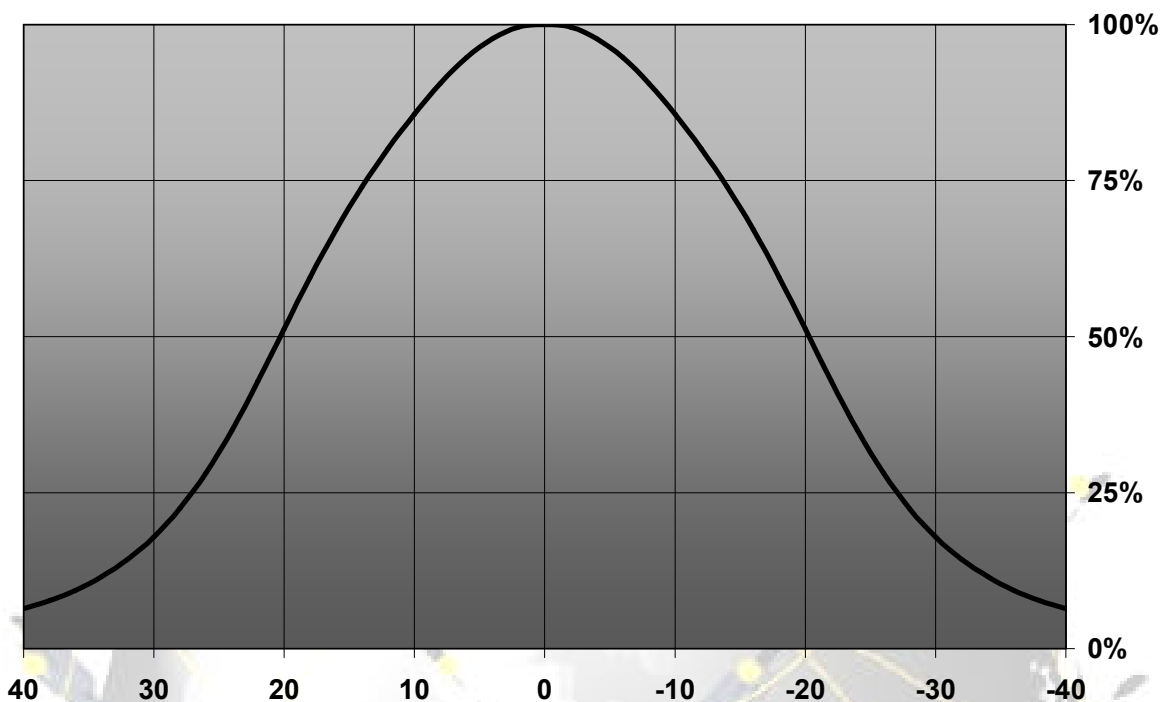

© Ledil Oy – PRELIMINARY - Subject to change without prior notice

DRAWINGS

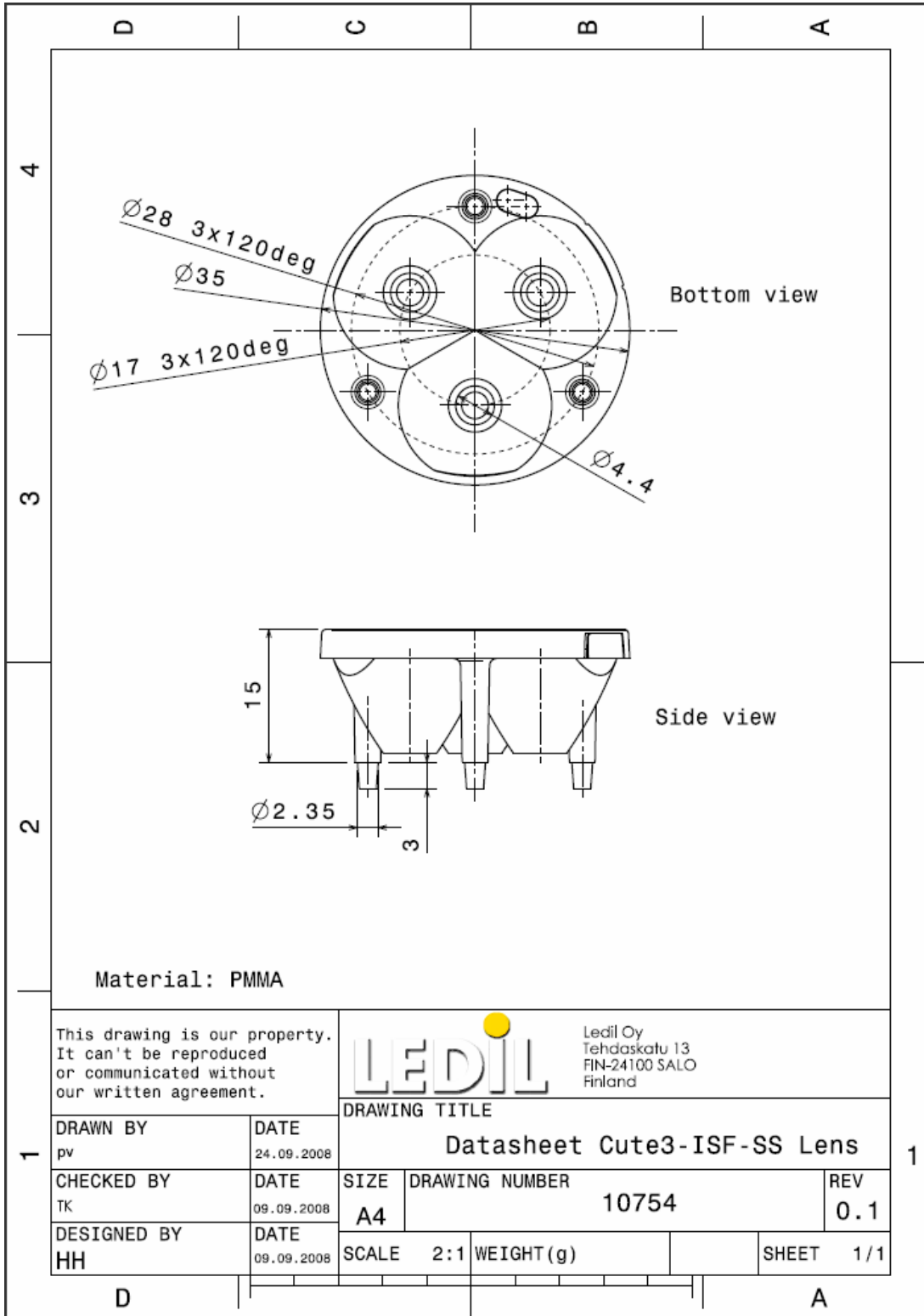

© Ledil Oy – PRELIMINARY - Subject to change without prior notice