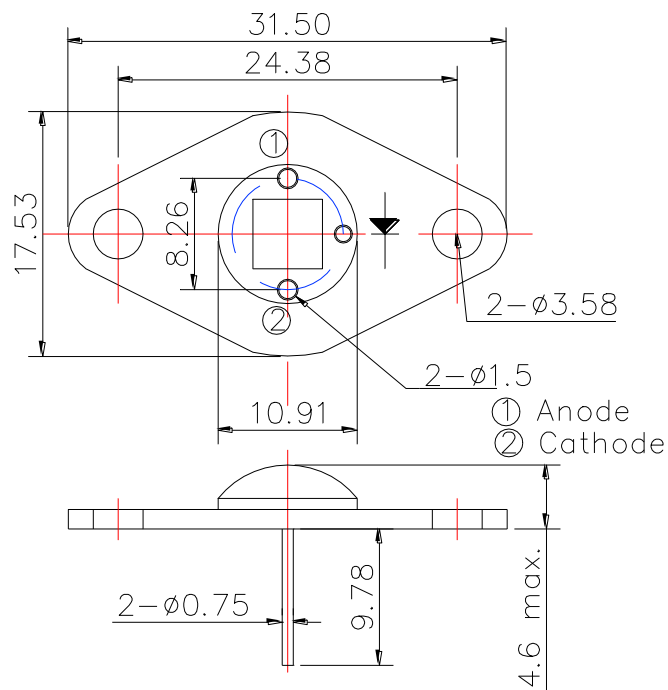

Data Sheet

L780D-66-16100

Red color illuminator

Outline and Internal Circuit

(Unit : mm)

Features

- Chip Material : AlGaAs
- Chip Dimension : 1000um * 1000um
- Number of Chips : 16pcs
- Peak Wavelength : 780nm typ.
- Package :
- Stem : TO-66 stem
- Lens : Silicone and/or Epoxy resin

Application

- Biometrics System
- Electronic Toll Collection
- Infrared Illumination for Cameras
- Machine Vision System

Absolute Maximum Ratings (Tc=25°C)

Item	Symbol	Ratings	Unit
Power Dissipation	PD	28	W
Forward Current	IF	3.2	A
Reverse Voltage	VR	20	V
Operating Temperature	Topr	-40 ~ +85	°C
Storage Temperature	Tstg	-40 ~ +100	°C
Soldering Temperature	TSOL	265	°C

‡Soldering condition : Soldering condition must be completed with 3 seconds at 265°C

Optical and Electrical Characteristics (Tc=25°C)

Parameter	Symbol	Min	Typ	Max	Unit	Test Condition
Forward Voltage	VF		8.7		V	IF=3.2A
Total Radiated Power	PO		5600		mW	IF=3.2A
Peak Wavelength	λ_p	770	780	790	nm	IF=3.2A
Half Width	$\Delta\lambda$		28		nm	IF=3.2A
Viewing Half Angle	$\theta_{1/2}$		±64		deg.	IF=100mA

‡ Radiated Power is measured by S3584-08.

Typical Characteristic Curves

Forward Current - Forward Voltage

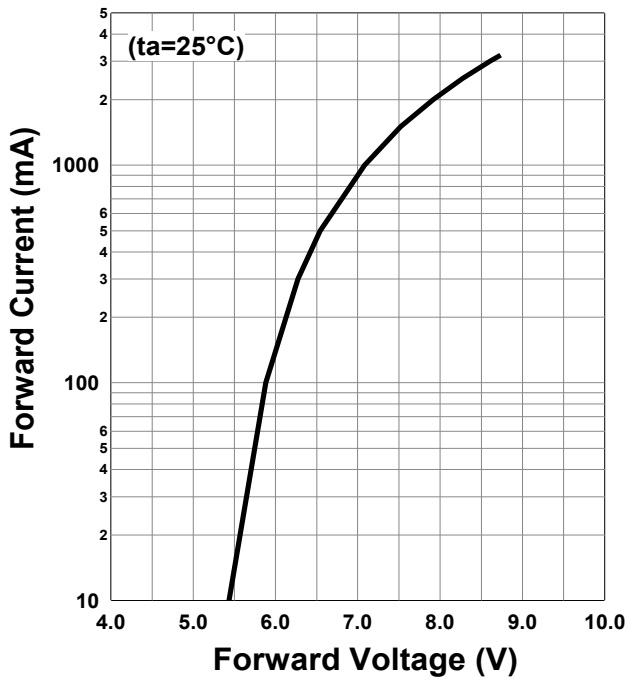

Relative Radiant Intensity - Forward Current

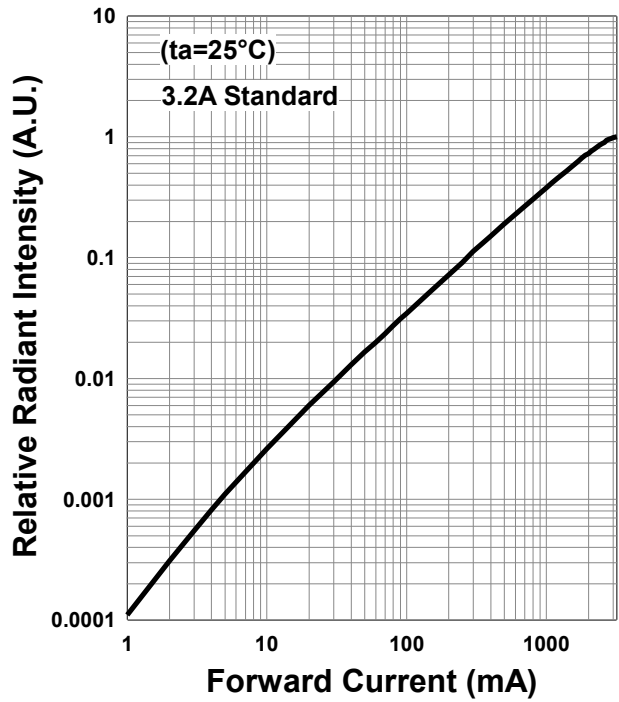

Radiation Characteristics

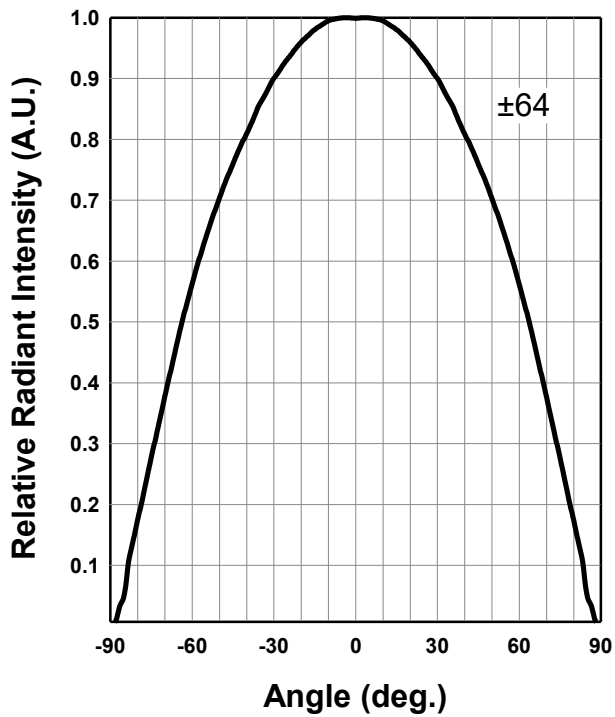

*The data below shows the characteristics of one representative TO-66 chip.

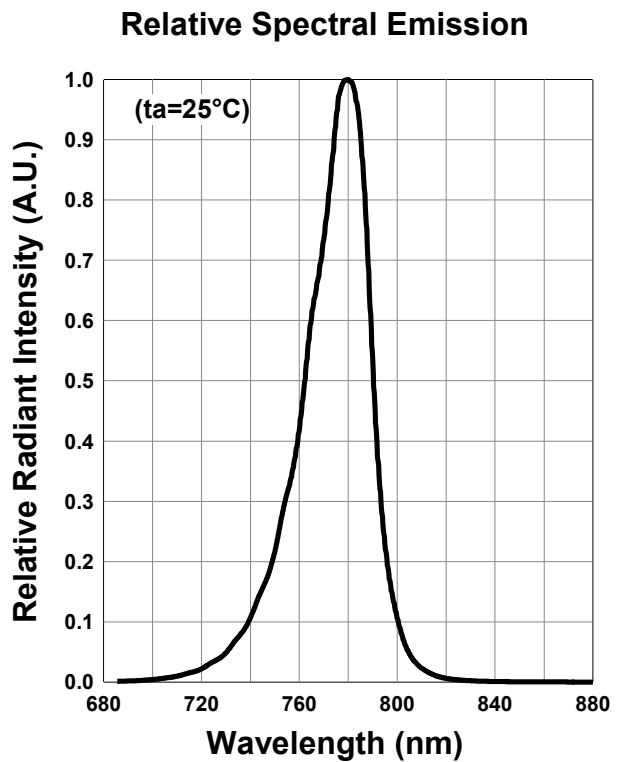
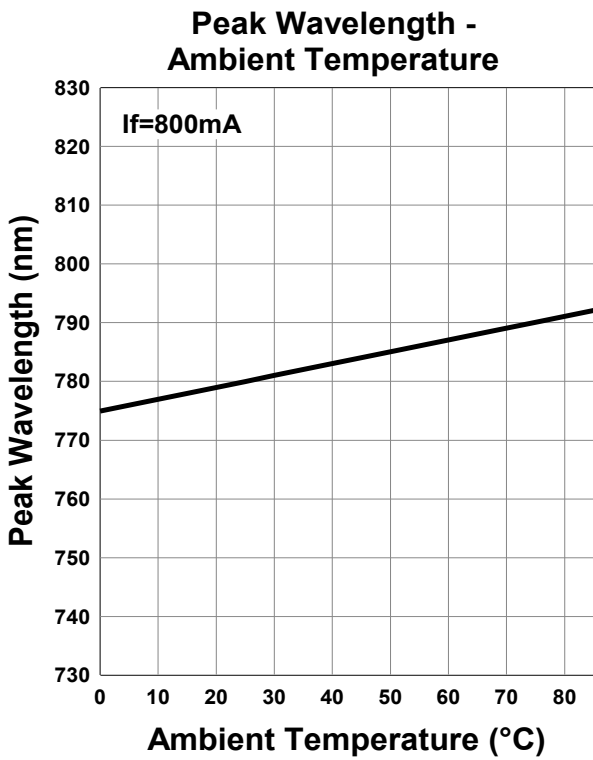
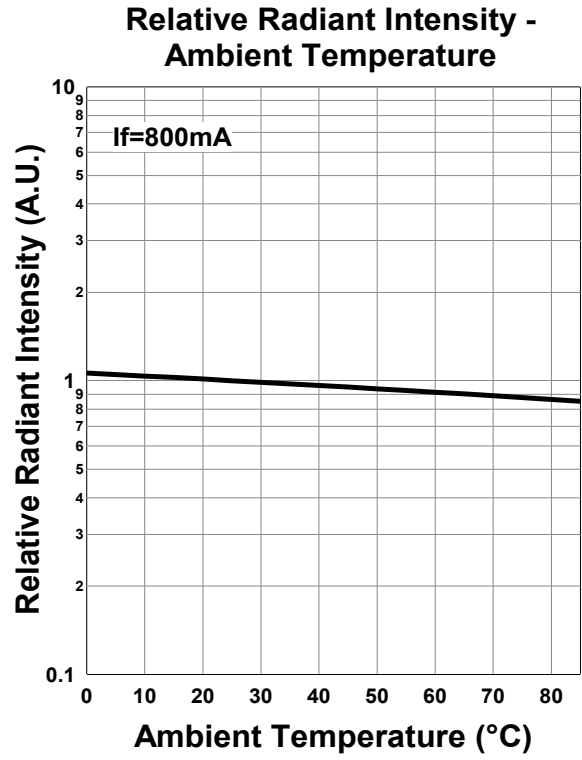
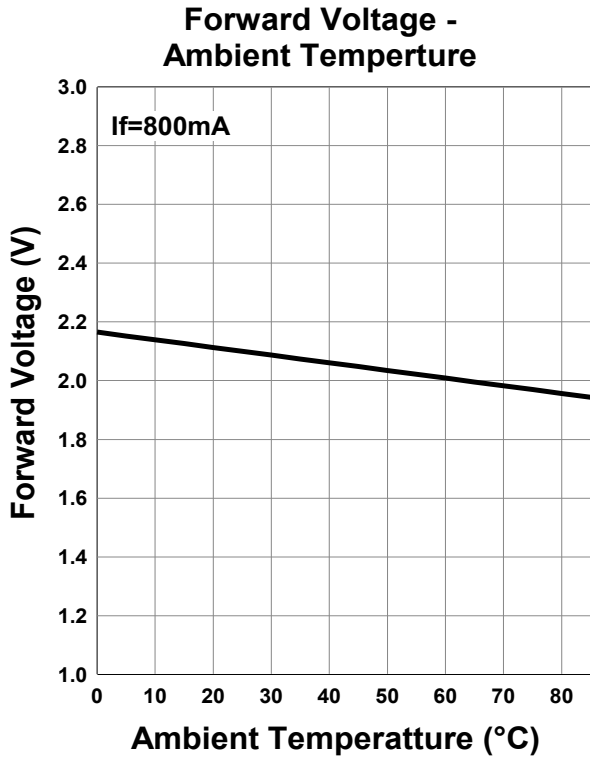

Disclaimer

Product specifications and data shown in this product catalog are subject to change without notice for the purposes of improving product performance, reliability, design, or otherwise.

Product data and parameters in this catalog are typical values based on reasonably up-to-date measurements.

Product data and parameters may vary by user application and over time.

Products shown in this catalog are intended to be used for general electronic equipment.

Products are not guaranteed for applications where product malfunction or failure may cause personal injury or death, including but not limited to life-supporting / saving devices, medical devices, safety devices, airplanes, aerospace equipment, automobiles, traffic control systems, and nuclear reactor control systems.

