

L1050D-66-60

Infrared illuminator

Outline and Internal Circuit

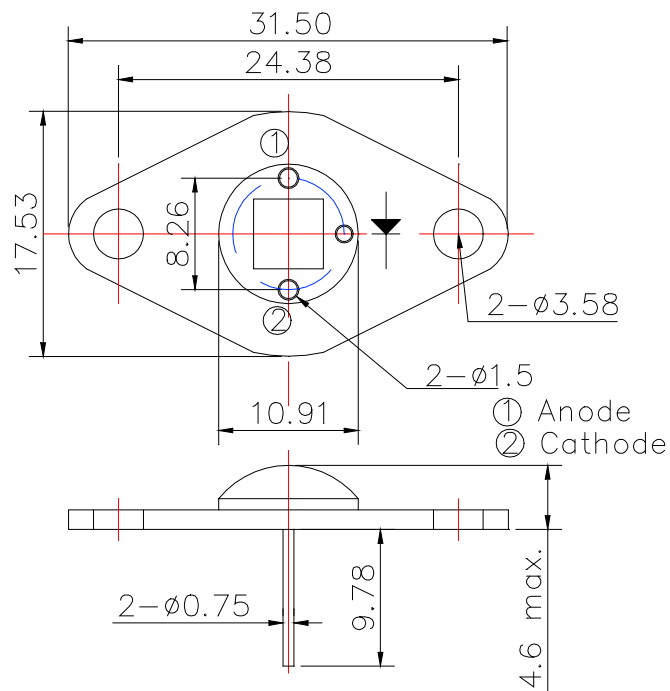

(Unit : mm)

Features

- Chip Material : InGaAsP
- Chip Dimension : 350um * 350um
- Number of Chips : 60pcs
- Peak Wavelength : 1050nm typ.
- Stem : TO-66 stem
- Lens : Silicone and/or Epoxy resin

Absolute Maximum Ratings (Tc=25°C)

Item	Symbol	Ratings	Unit
Power Dissipation	PD	9000	mW
Forward Current	IF	1200	mA
Reverse Voltage	VR	25	V
Thermal Resistance	Rthjs	2	K/W
Junction Temperature	Tj	120	°C
Operating Temperature	Topr	-40 ~ +85	°C
Storage Temperature	Tstg	-40 ~ +100	°C

‡Soldering condition : Refer to technical support information on the website.

Optical and Electrical Characteristics (Tc=25°C)

(*: 100% testing, **: reference value)

Parameter	Symbol	Min	Typ	Max	Unit	Test Condition
Forward Voltage	VF		6.5	7.5	V	IF=600mA**
Reverse Current	IR			10	uA	VR=25V**
Total Radiated Power	PO		570		mW	IF=600mA**
Peak Wavelength	λ_p	1020		1080	nm	IF=100mA*
Half Width	$\Delta\lambda$		50		nm	IF=100mA**
Viewing Half Angle	$\theta_{1/2}$		± 62		deg.	IF=100mA**
Rise Time	tr		60		ns	IF=600mA**
Fall Time	tf		30		ns	IF=600mA**

‡ Radiated Power is measured by G8370-85.

Typical Characteristic Curves

Forward Current - Forward Voltage

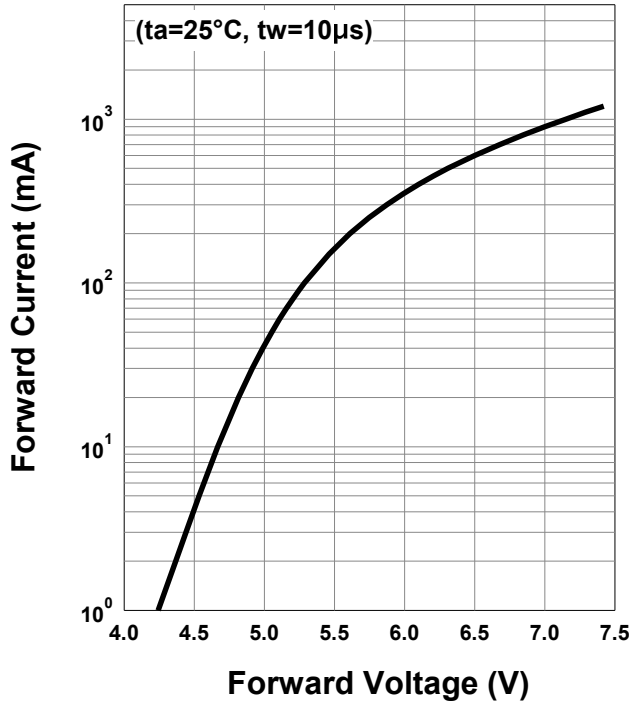

Relative Radiant Intensity - Forward Current

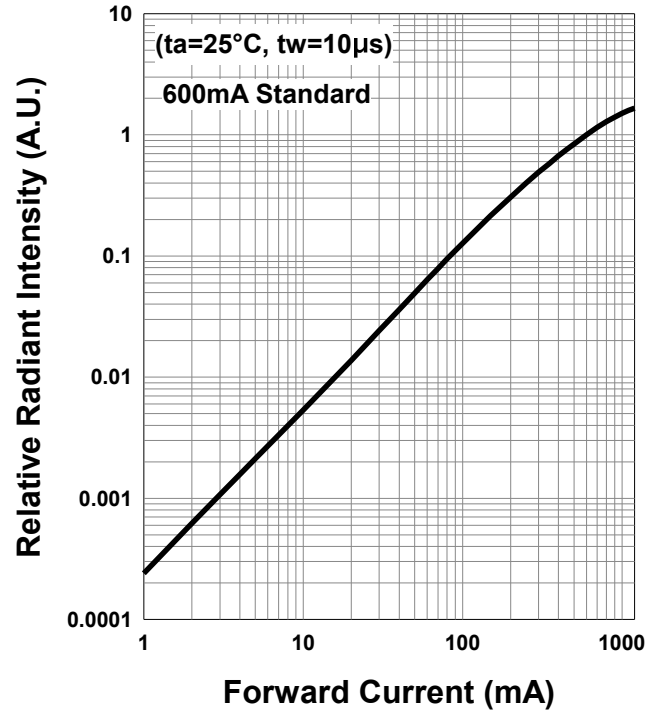

Allowable Forward Current - Ambient Temperature

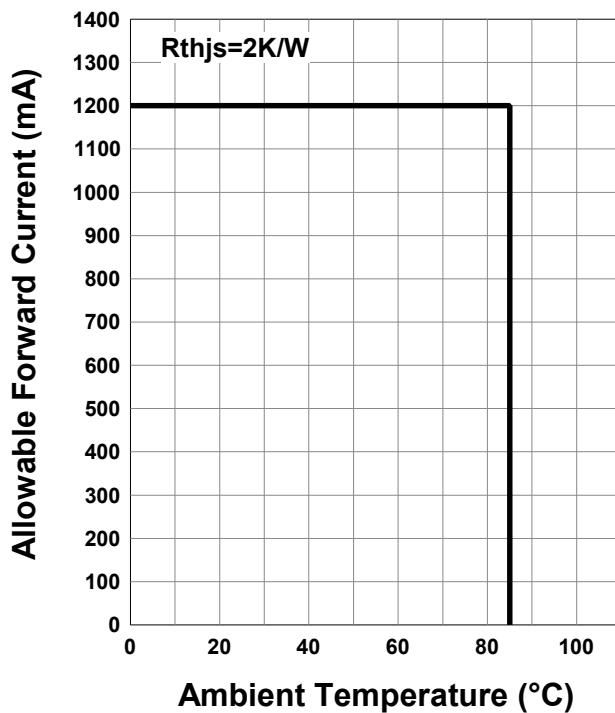

Radiation Characteristics

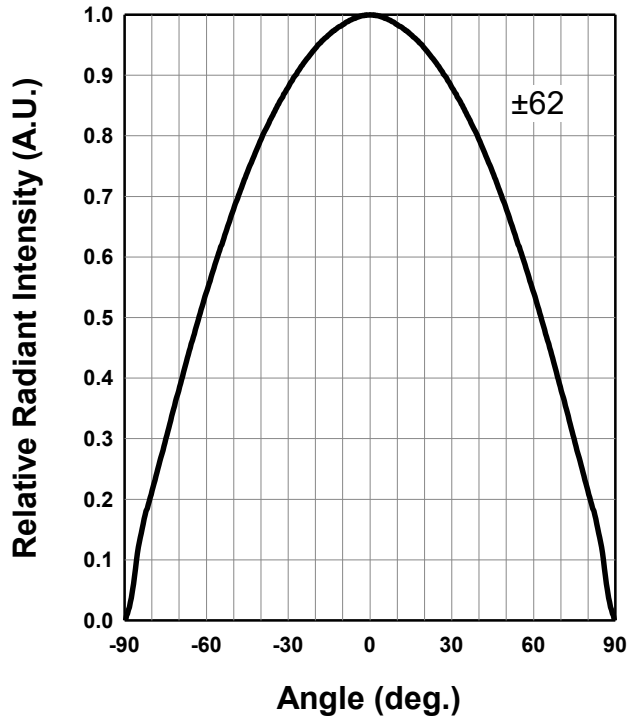

Radiation Characteristics

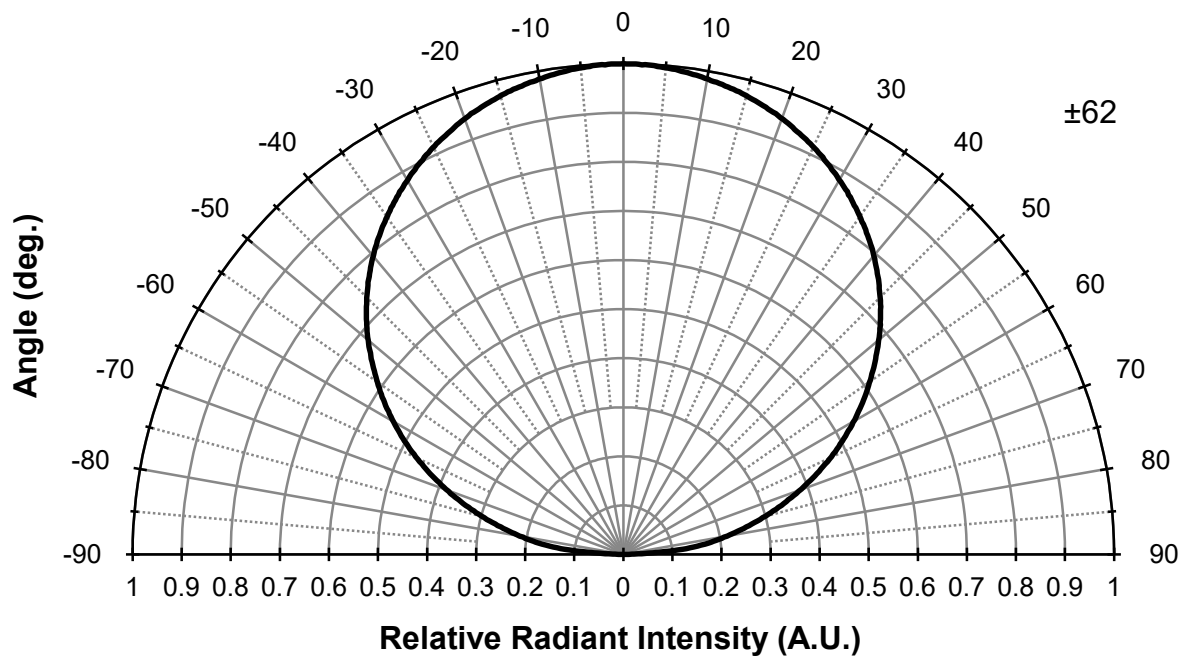

*The data below shows the characteristics of one representative TO-66 chip.

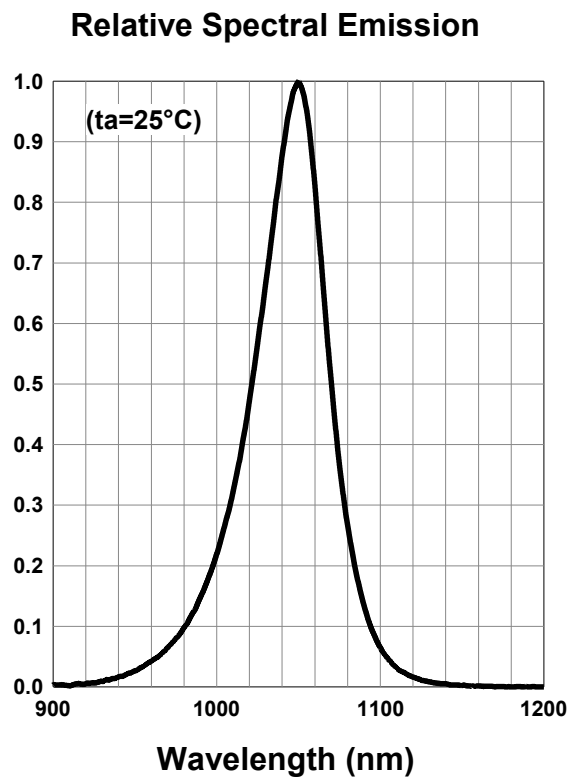
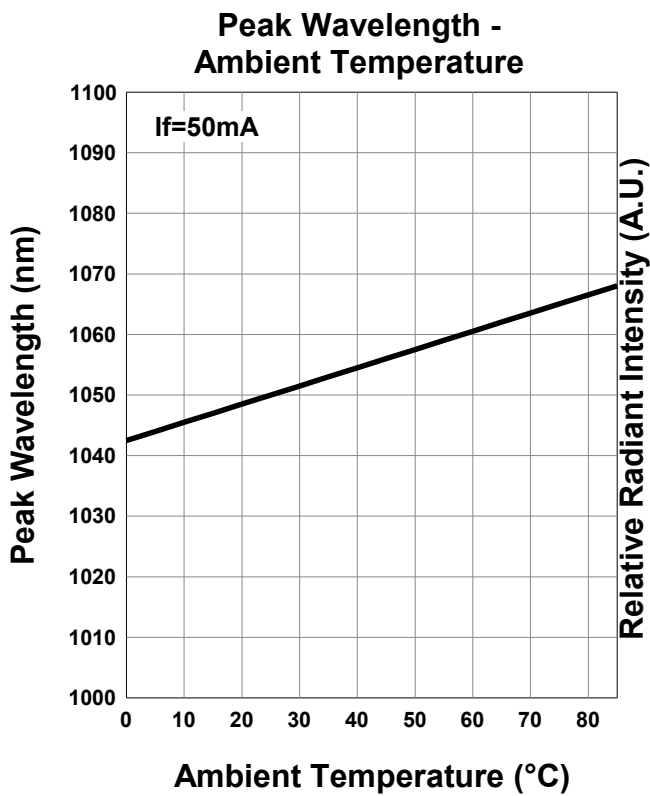
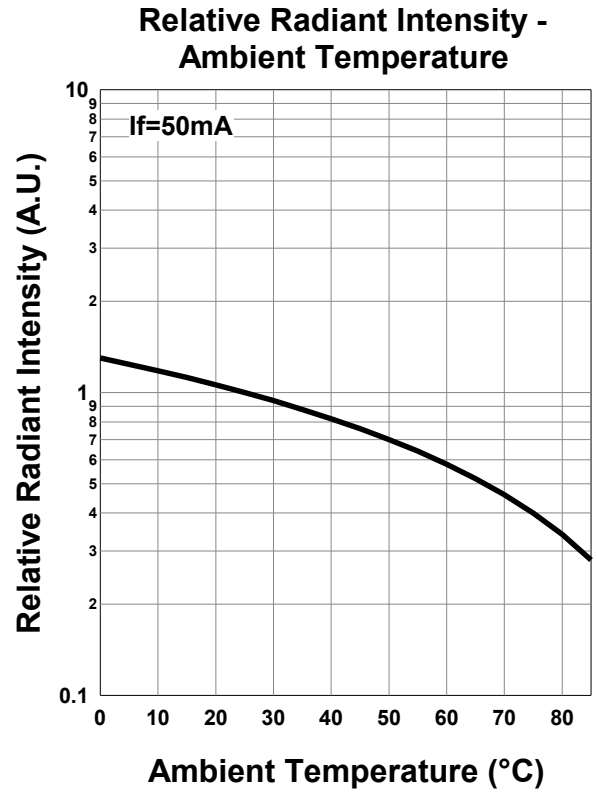
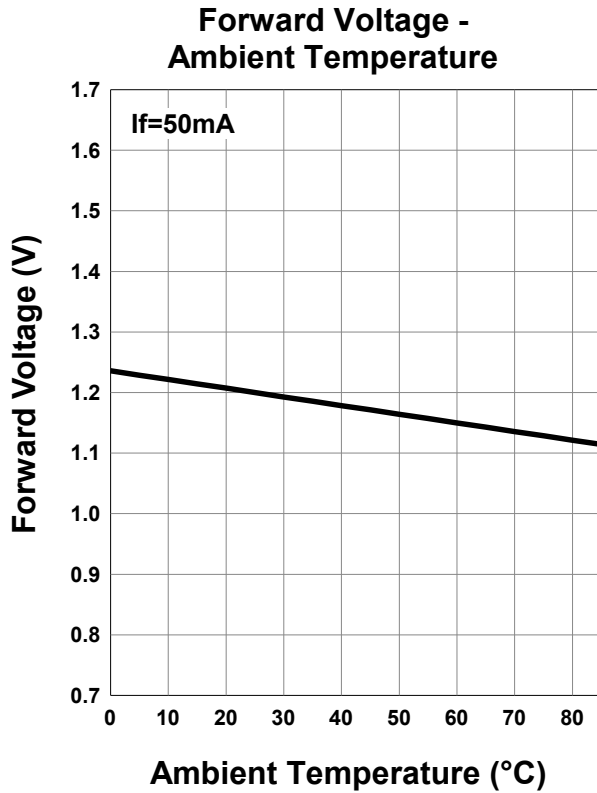

Disclaimer

Product specifications and data shown in this product catalog are subject to change without notice for the purposes of improving product performance, reliability, design, or otherwise.

Product data and parameters in this catalog are typical values based on reasonably up-to-date measurements.

Product data and parameters may vary by user application and over time.

Products shown in this catalog are intended to be used for general electronic equipment. Products are not guaranteed for applications where product malfunction or failure may cause personal injury or death, including but not limited to life-supporting / saving devices, medical devices, safety devices, airplanes, aerospace equipment, automobiles, traffic control systems, and nuclear reactor control systems.



2302②-NP