

C1750F-2717-X

PRELIMINARY

InGaAsP IR LED Chip

Outline

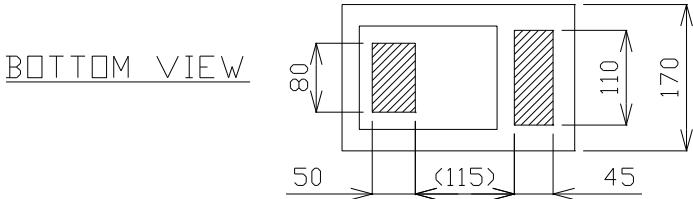
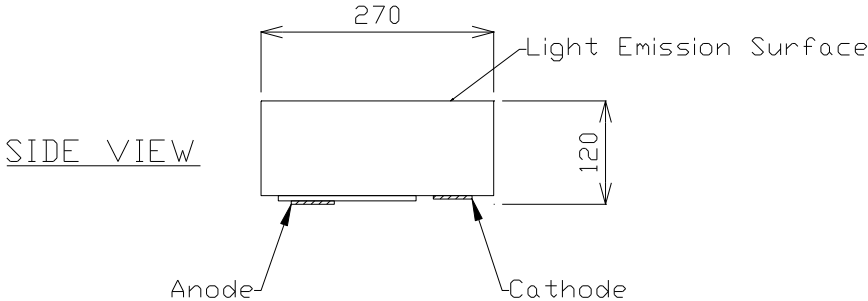

UNIT: μm

Characteristics

- Materials: InGaAsP
- Dimension
 - Chip Size: 270 +/- 30 μm x 170 +/- 30 μm
 - Chip thickness: 120 +/- 25 μm
- Bonding pad: Au

Absolute Maximum Ratings

Item	Symbol	Condition	Ratings	Unit
Forward Current	IF	Ta=25 °C	20	mA
Reverse Voltage	VR	Ta=25 °C	3	V
Junction Temperature	Tj	-	120	°C
Operating Temperature	Topr	-	-40 ~ +100	°C
Storage Temperature	Tstg	Chip on Tape	+5 ~ +30	°C

‡ Maximum Ratings are dependent on package.

Optical and Electrical Characteristics (Tc=25°C)⁽¹⁾

Parameter	Symbol	Condition	Min	Typ	Max	Unit
Forward Voltage	VF1	IF=20mA ⁽³⁾	0.8	1.1	1.4	V
Total Radiated Power ⁽²⁾	PO1	IF=20mA ⁽³⁾	0.8	1.2		mW
Reverse Current	IR	VR=3V			10	uA
Peak Wavelength	λ_p	IF=20mA ⁽³⁾	1700	1750	1800	nm
Spectral Half Width	$\Delta\lambda$	IF=20mA ⁽³⁾		220		nm
Rise Time	tr	IF=20mA		70		ns
Fall Time	tf	IF=20mA		40		ns

(1) Die shall be mounted on TO-18 gold header without resin coated.

(2) Radiated Power is measured by G8370-85.

(3) Applied time is 10msec.

Typical Characteristic Curves

Forward Current - Forward Voltage

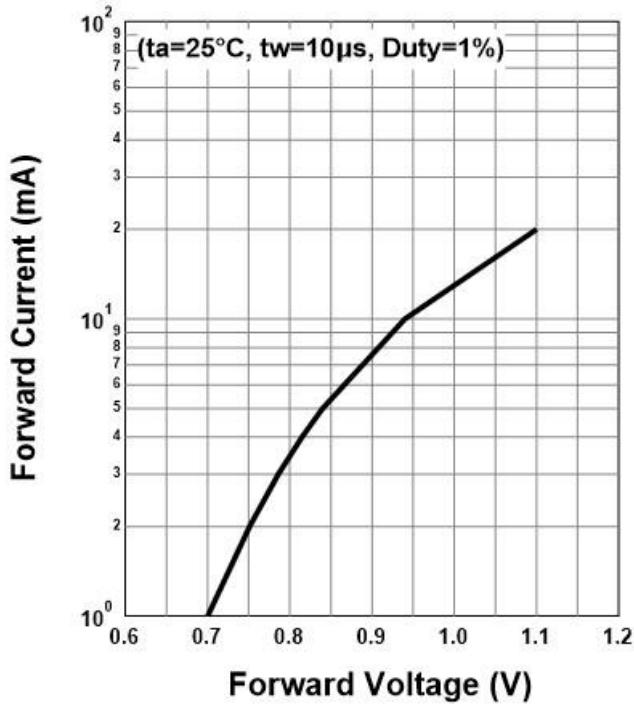

Relative Radiant Intensity - Forward Current

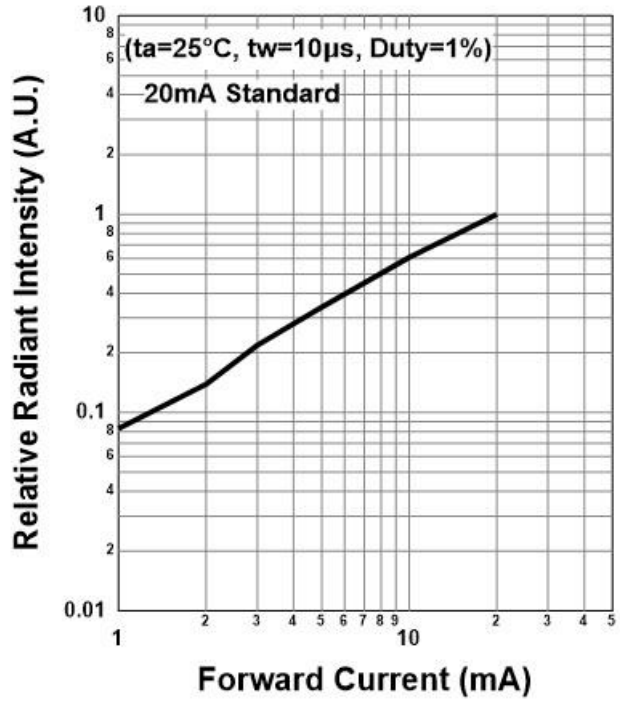

Relative Spectral Emission

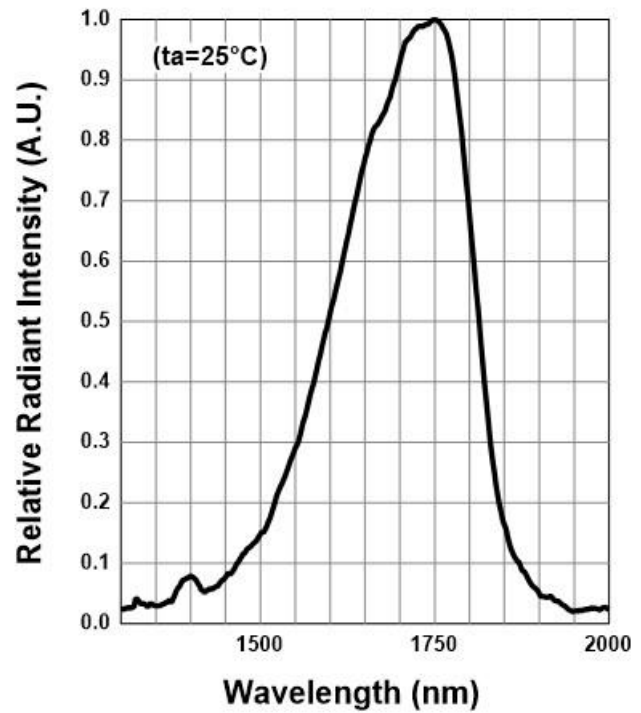

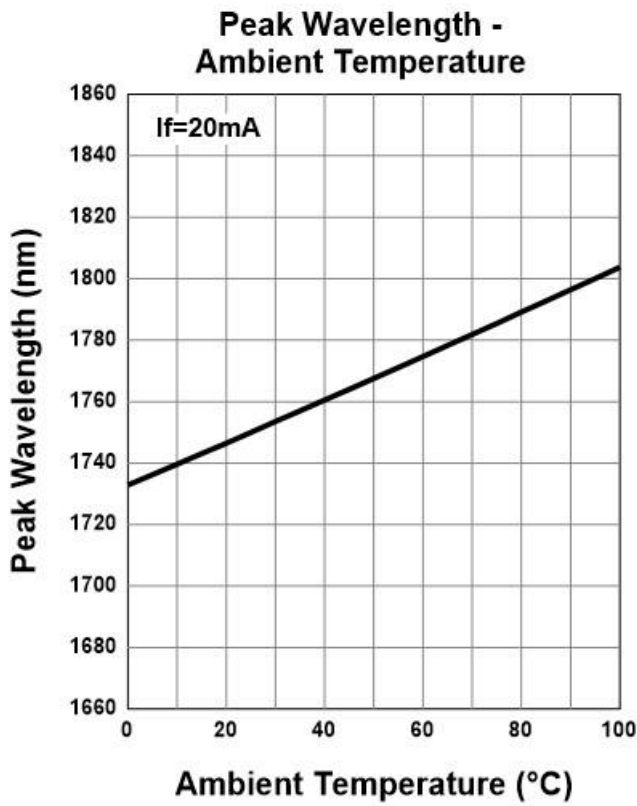
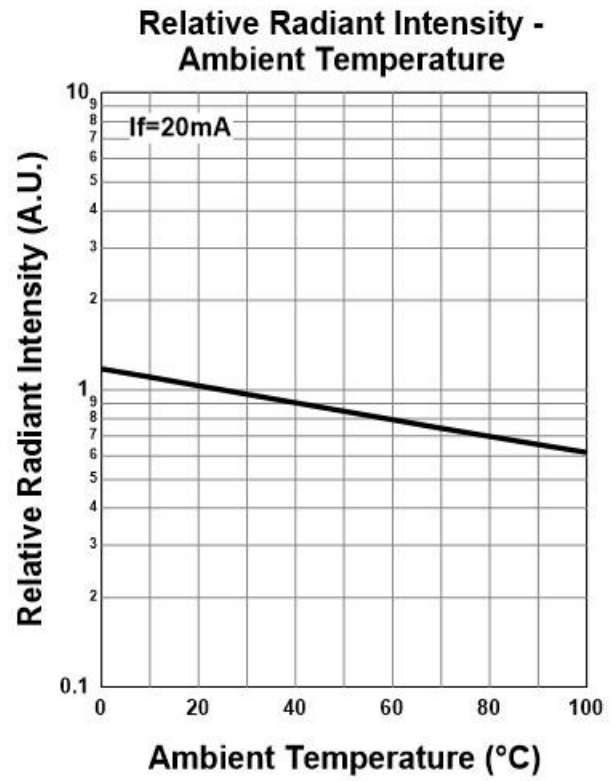
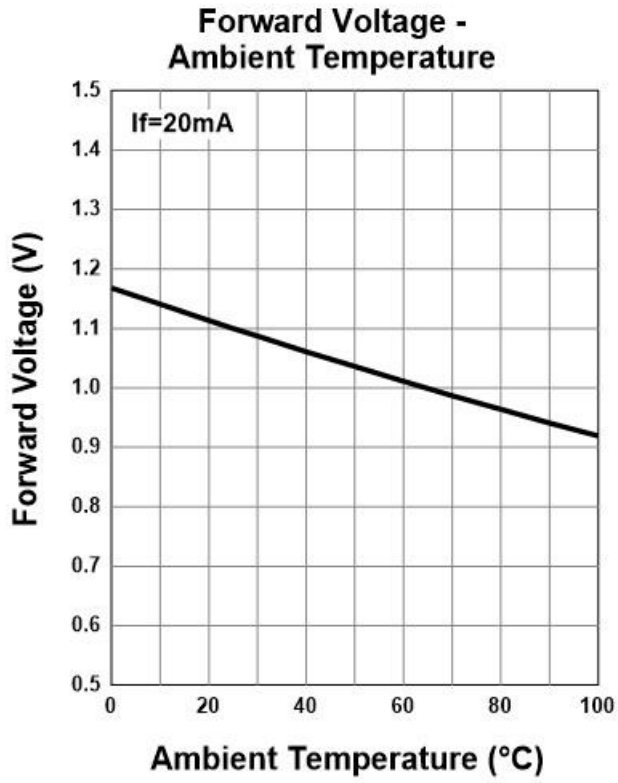

Disclaimer

Product specifications and data shown in this product catalog are subject to change without notice for the purposes of improving product performance, reliability, design, or otherwise.

Product data and parameters in this catalog are typical values based on reasonably up-to-date measurements.

Product data and parameters may vary by user application and over time.

Products shown in this catalog are intended to be used for general electronic equipment. Products are not guaranteed for applications where product malfunction or failure may cause personal injury or death, including but not limited to life-supporting / saving devices, medical devices, safety devices, airplanes, aerospace equipment, automobiles, traffic control systems, and nuclear reactor control systems.

Others

Please do not disassemble, analyze or reverse engineer without our permission.

The product is manufactured by USHIO Inc. and the spec information is also from USHIO Inc.



Email: sales@tech-led.com